

ANGELINA-S-B

~20° spot beam compatible with BJB connectors

TECHNICAL SPECIFICATIONS:

Dimensions	Ø 82 mm
Height	31 mm
Fastening	socket
Colour	metal
Box size	480 x 280 x 300 mm
Box weight	11.3 kg
Quantity in Box	2035 pcs
ROHS compliant	yes ⓘ

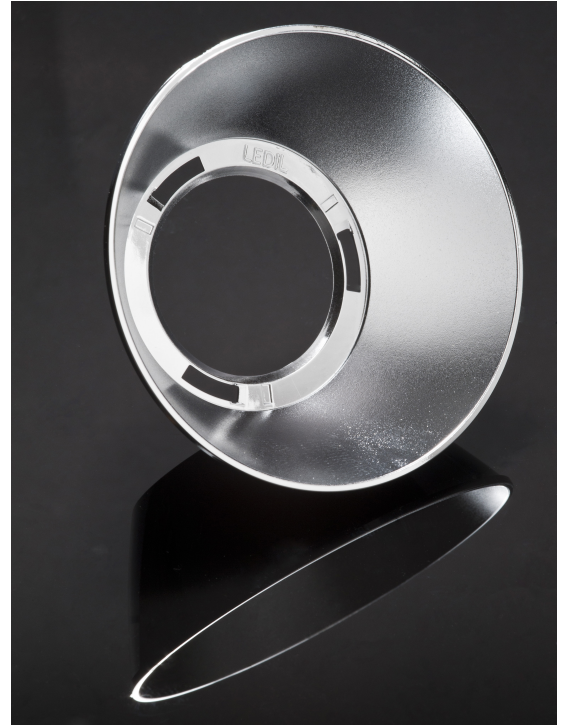

MATERIAL SPECIFICATIONS:

Component	Type	Material	Colour	Coating
ANGELINA-S-B	Reflector	PC	metal	HMDS

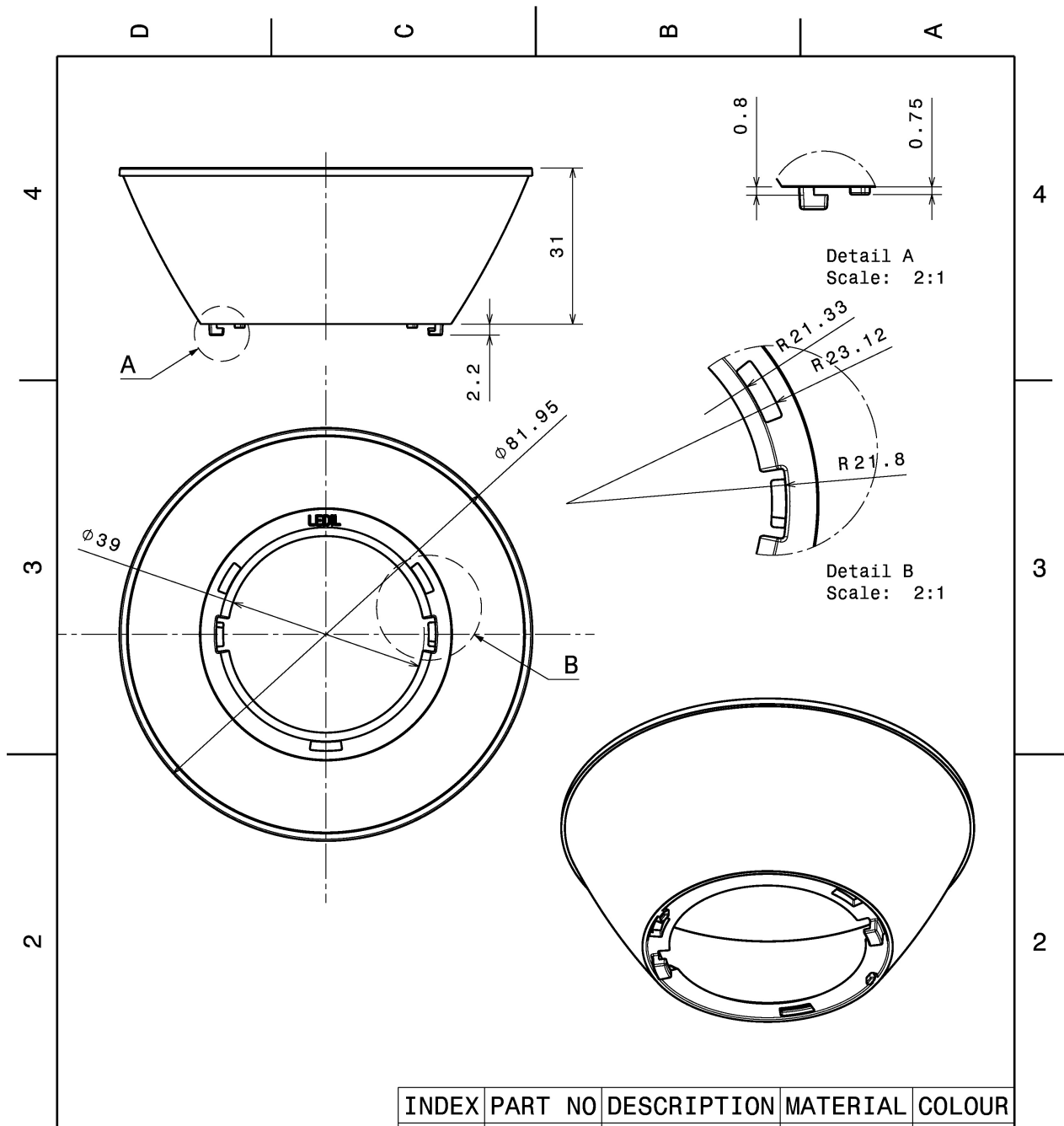

INDEX	PART NO	DESCRIPTION	MATERIAL	COLOUR
1		ANGELINA-B	PC	metal

Tolerances if not otherwise shown
According to DIN ISO 2768-1
Linear measures:
Up to 30mm class M, otherwise class C.
According to DIN ISO 2768-2
Form and position: class L

LEDiL Ledil Oy
Salorankatu 10
FIN 24240 SALO
Finland

THIRD ANGLE PROJECTION:

DRAWING TITLE
ANGELINA-B series Reflector

This drawing is the property of LEDiL Oy. It may not be reproduced, copied or communicated without a written agreement with LEDiL Oy."

SIZE	PART NUMBER
A4	-

SCALE	1:1	WEIGHT	-	SHEET	1/1
-------	-----	--------	---	-------	-----

PHOTOMETRIC DATA (MEASURED):

<p>bridgelux.</p> <p>LED BXRA ES Rectangle</p> <p>FWHM 23.0°</p> <p>Efficiency 92 %</p> <p>Peak intensity 2.170 cd/lm</p> <p>Required components: BJB: 47.319.2040</p>		
<p>bridgelux.</p> <p>LED V15 Gen6</p> <p>FWHM 24.0°</p> <p>Efficiency 92 %</p> <p>Peak intensity 2.000 cd/lm</p> <p>Required components: BJB: 47.319.2224</p>		
<p>bridgelux.</p> <p>LED V18 Gen6</p> <p>FWHM 27.0°</p> <p>Efficiency 92 %</p> <p>Peak intensity 1.800 cd/lm</p> <p>Required components: BJB: 47.319.2274</p>		
<p>bridgelux.</p> <p>LED V18 Gen7</p> <p>FWHM 27.0°</p> <p>Efficiency 93 %</p> <p>Peak intensity 1.800 cd/lm</p> <p>Required components: BJB: 47.319.2350</p>		

PHOTOMETRIC DATA (MEASURED):

CITIZEN

LED CLL03x/CLU03x
 FWHM 25.0°
 Efficiency 89 %
 Peak intensity 1.820 cd/lm
 Required components:
 F13671_ANGE-RZ-LENS
 A.A.G. STUCCHI: 8101/G2

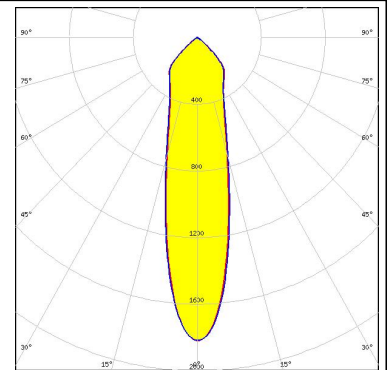

CITIZEN

LED CLL03x/CLU03x
 FWHM 22.0°
 Efficiency 94 %
 Peak intensity 2.250 cd/lm
 Required components:
 A.A.G. STUCCHI: 8101/G2

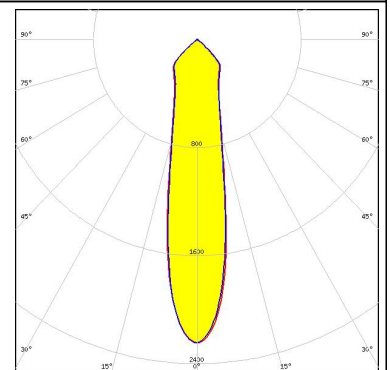
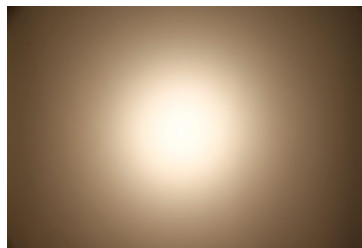

CITIZEN

LED CLL03x/CLU03x
 FWHM 23.0°
 Efficiency 92 %
 Peak intensity 2.150 cd/lm
 Required components:
 BJB: 47.319.2021

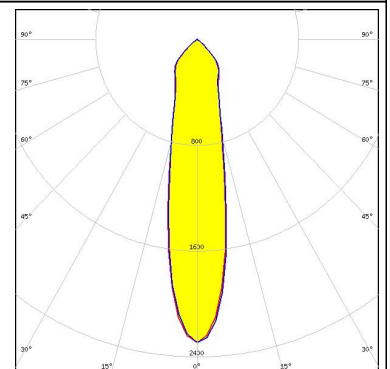
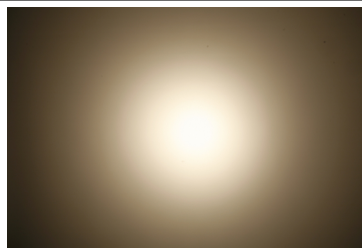

CITIZEN

LED CLL04x/CLU04x
 FWHM 33.0°
 Efficiency 88 %
 Peak intensity 1.390 cd/lm
 Required components:
 F13671_ANGE-RZ-LENS
 A.A.G. STUCCHI: 8102/G2

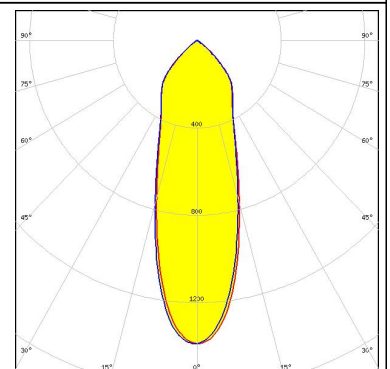
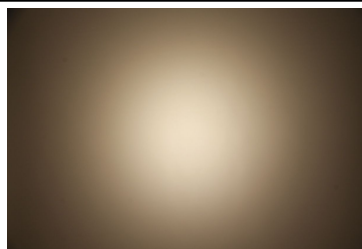

PHOTOMETRIC DATA (MEASURED):

CITIZEN

LED CLL04x/CLU04x
FWHM 30.0°
Efficiency 92 %
Peak intensity 1.600 cd/lm
Required components:
A.A.G. STUCCHI: 8102/G2

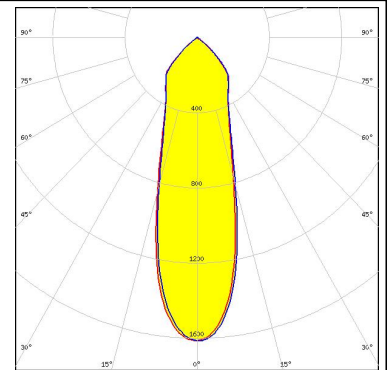
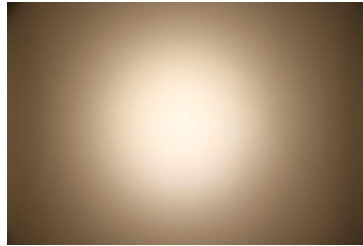

CITIZEN

LED CLU720/721
FWHM 19.0°
Efficiency 94 %
Peak intensity 2.500 cd/lm
Required components:
A.A.G. STUCCHI: 8101/G2

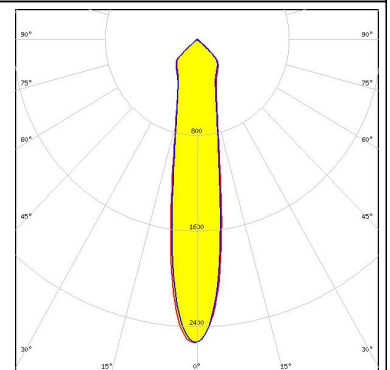
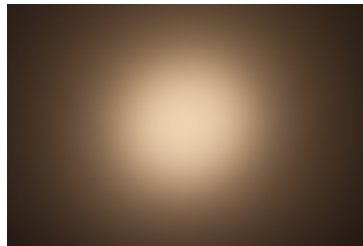

CITIZEN

LED CLU720/721
FWHM 19.0°
Efficiency 94 %
Peak intensity 2.700 cd/lm
Required components:
BJB: 47.319.2021

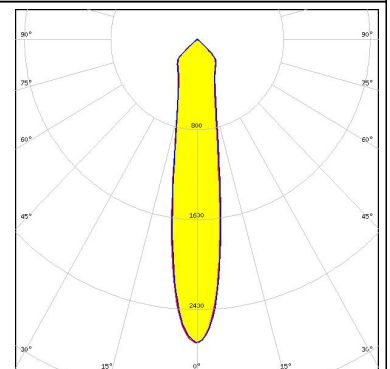
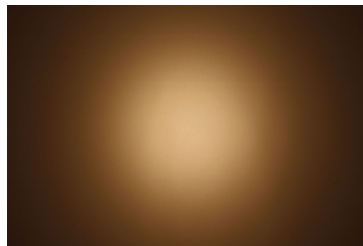

CREE

LED CXA/B 25xx
FWHM 27.0°
Efficiency 92 %
Peak intensity 1.800 cd/lm
Required components:
BJB: 47.319.2141

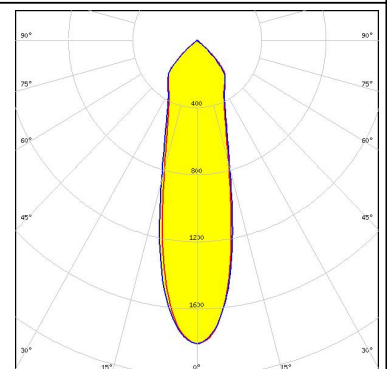
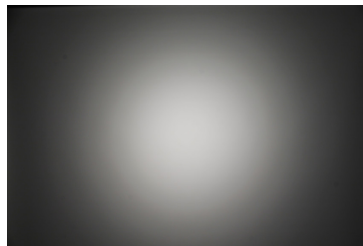

PHOTOMETRIC DATA (MEASURED):



LED CXA/B 25xx
 FWHM 25.0°
 Efficiency 93 %
 Peak intensity 2.000 cd/lm
 Required components:
 A.A.G. STUCCHI: 8401/G2

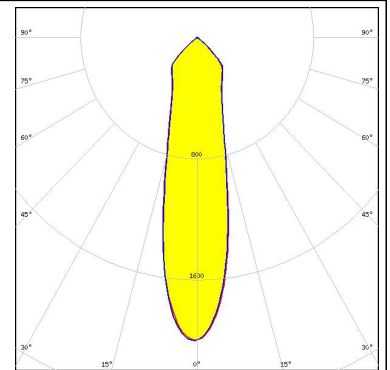
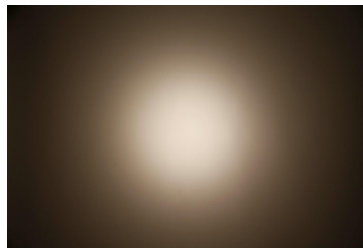

LED CXA/B 25xx
 FWHM 30.0°
 Efficiency 88 %
 Peak intensity 1.500 cd/lm
 Required components:
 F13671_ANGE-RZ-LENS
 BJB: 47.319.2141

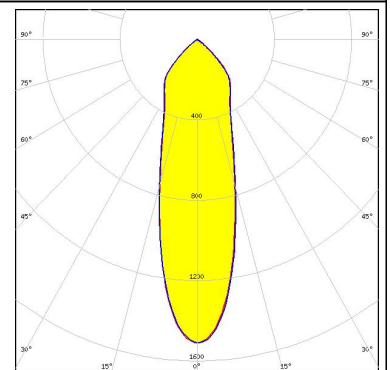
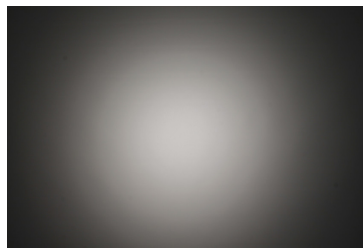

LED CXA/B 30xx
 FWHM 30.0°
 Efficiency 92 %
 Peak intensity 1.660 cd/lm
 Required components:
 A.A.G. STUCCHI: 8404/G2

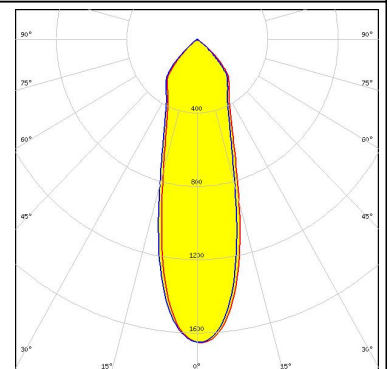
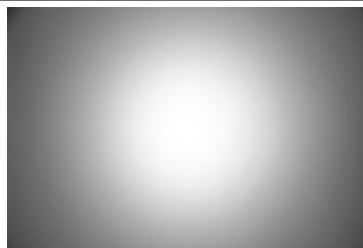

LED COB 10W/13W/17W/24W
 FWHM 21.0°
 Efficiency 93 %
 Peak intensity 2.300 cd/lm
 Required components:
 BJB: 47.319.2080

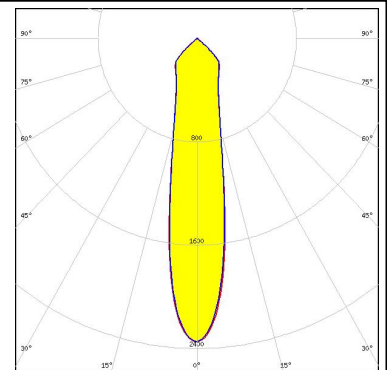
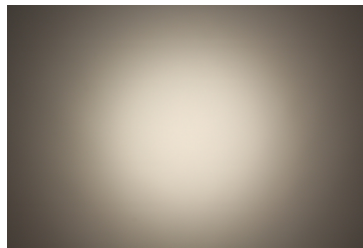

PHOTOMETRIC DATA (MEASURED):

LG Innotek

LED COB 10W/13W/17W/24W
 FWHM 21.0°
 Efficiency 94 %
 Peak intensity 2.400 cd/lm
 Required components:
 A.A.G. STUCCHI: 8600/G2

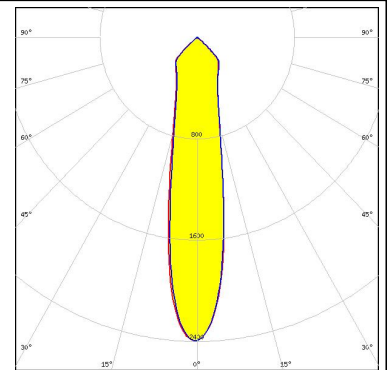

LG Innotek

LED COB 40W/60W
 FWHM 31.0°
 Efficiency 92 %
 Peak intensity 1.600 cd/lm
 Required components:
 A.A.G. STUCCHI: 8102/G2

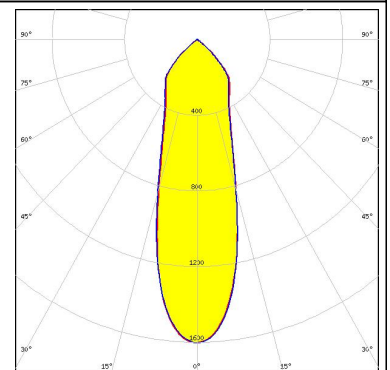
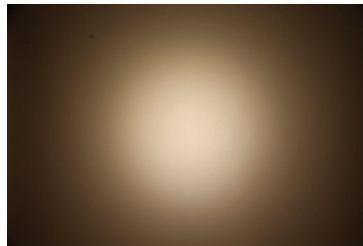

LUMILEDS

LED LUXEON CoB 1204/1205
 FWHM 21.0°
 Efficiency 94 %
 Peak intensity 2.430 cd/lm
 Required components:
 A.A.G. STUCCHI: 8301/G2

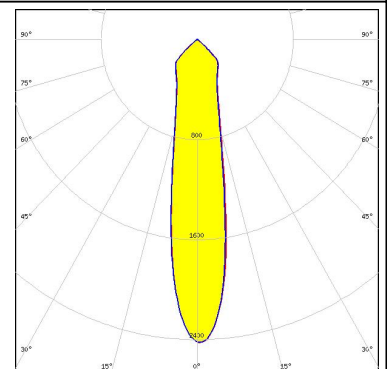
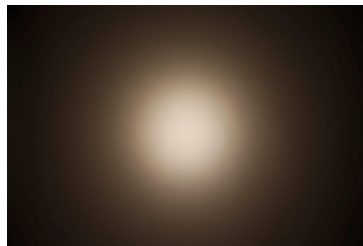

LUMILEDS

LED LUXEON CoB 1208
 FWHM 23.0°
 Efficiency 94 %
 Peak intensity 2.230 cd/lm
 Required components:
 A.A.G. STUCCHI: 8301/G2

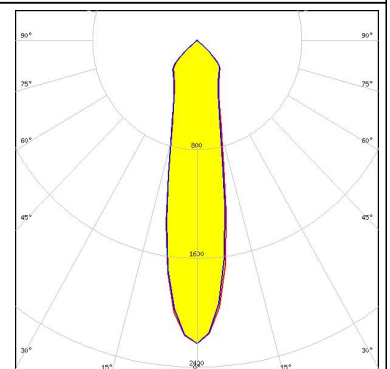
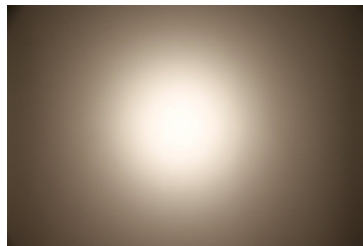

PHOTOMETRIC DATA (MEASURED):



LED LUXEON CoB 1211
 FWHM 26.0°
 Efficiency 92 %
 Peak intensity 1.880 cd/lm
 Required components:
 A.A.G. STUCCHI: 8102/G2

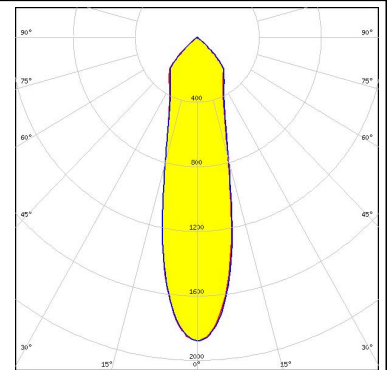
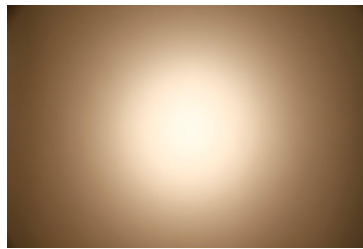

LED LUXEON CoB 1211
 FWHM 26.0°
 Efficiency 92 %
 Peak intensity 1.900 cd/lm
 Required components:
 BJB: 47.319.2030

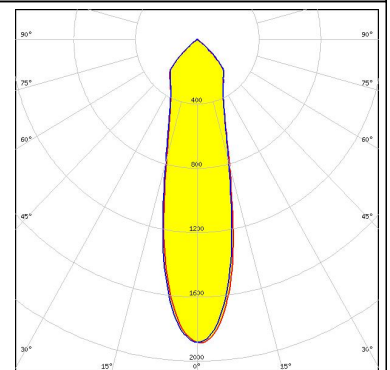
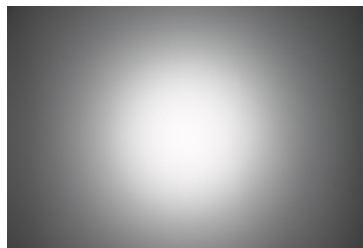

LED LUXEON CoB 1216/1812
 FWHM 34.0°
 Efficiency 88 %
 Peak intensity 1.350 cd/lm
 Required components:
 F13671_ANGE-RZ-LENS
 BJB: 47.319.2030

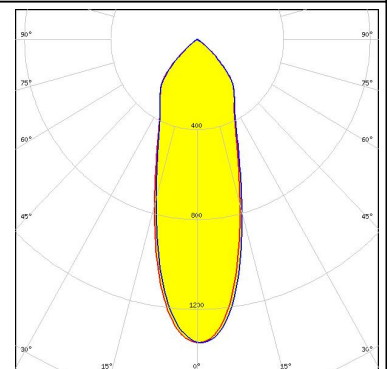
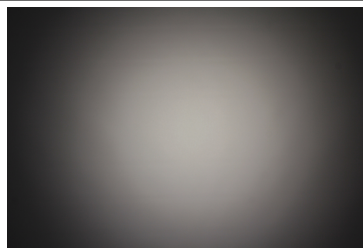

LED LUXEON CoB 1216/1812
 FWHM 32.0°
 Efficiency 91 %
 Peak intensity 1.550 cd/lm
 Required components:
 BJB: 47.319.2030

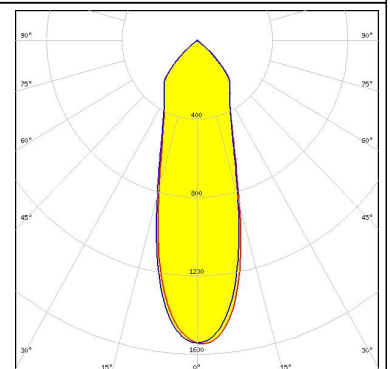
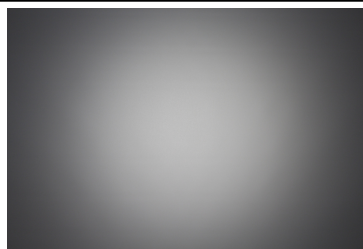

PHOTOMETRIC DATA (MEASURED):



LED LUXEON K12
 FWHM 27.0°
 Efficiency 89 %
 Peak intensity 1.600 cd/lm
 Required components:
 F13671_ANGE-RZ-LENS
 BJB: 47.319.2070

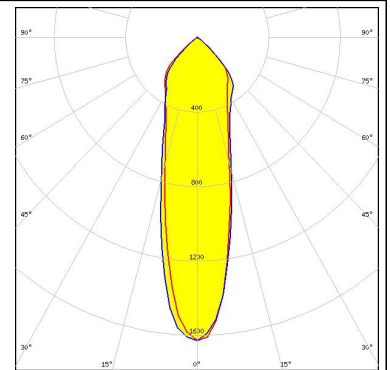

LED LUXEON K16
 FWHM 29.0°
 Efficiency 89 %
 Peak intensity 1.500 cd/lm
 Required components:
 F13671_ANGE-RZ-LENS
 BJB: 47.319.2070

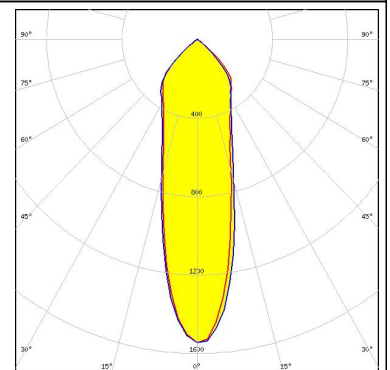
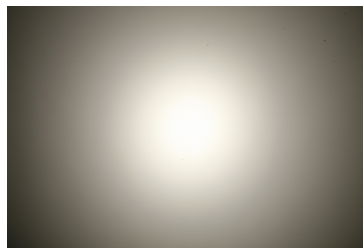

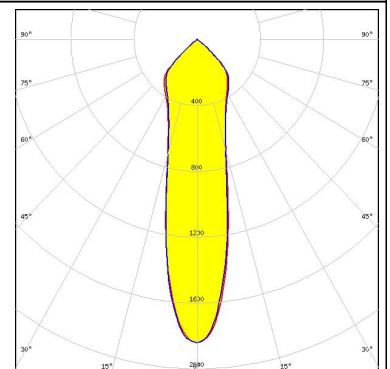
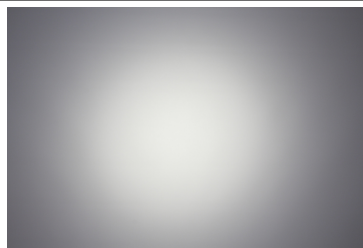

LED LUXEON K16
 FWHM 24.0°
 Efficiency 94 %
 Peak intensity 1.800 cd/lm
 Required components:
 BJB: 47.319.2070

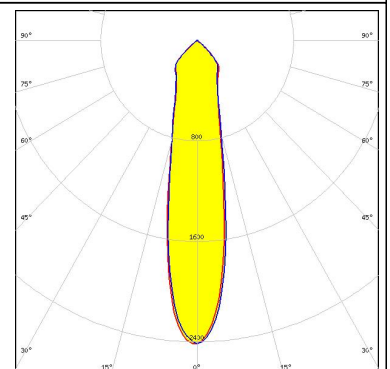
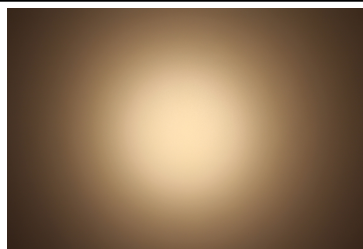

LED CXM-14
 FWHM 23.0°
 Efficiency 94 %
 Peak intensity 2.400 cd/lm
 Required components:
 BJB: 47.319.2021

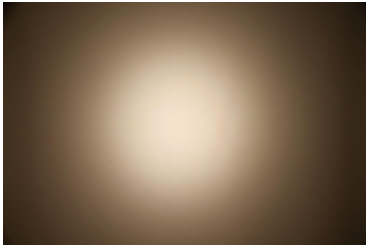
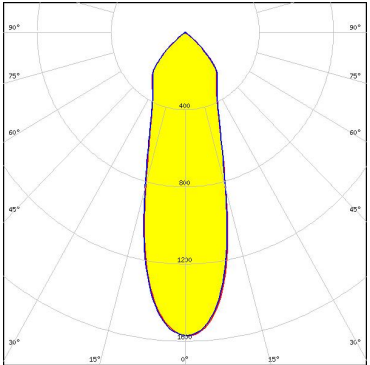
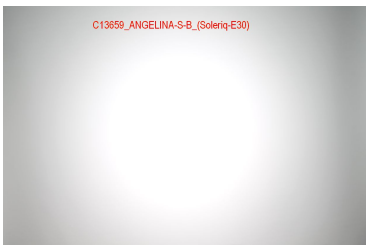
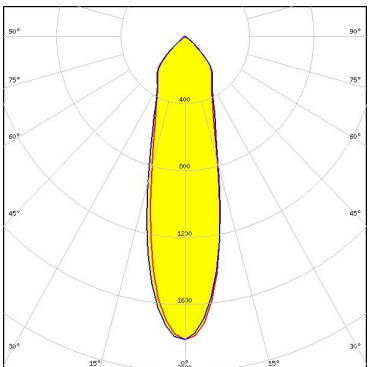

PHOTOMETRIC DATA (MEASURED):

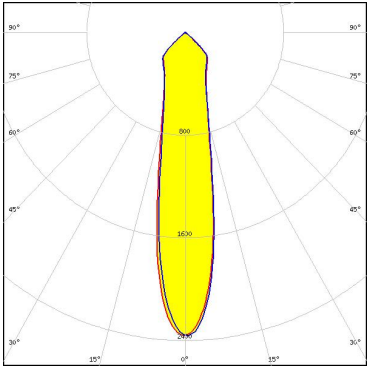
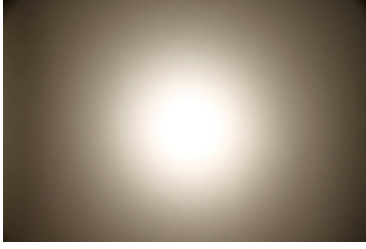
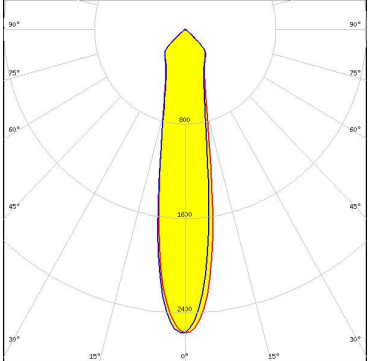
<p>LUMINUS</p> <p>LED CXM-22 FWHM 32.0° Efficiency 92 % Peak intensity 1.600 cd/lm Required components: BJB: 47.319.2030</p>		
<p>OSRAM <small>Opto Semiconductors</small></p> <p>LED Soleriq E30 FWHM 28.0° Efficiency 90 % Peak intensity 1.800 cd/lm Required components: BJB: 47.319.2090</p>	<p>C13659_ANGELINA-S-B_(Soleriq-E30)</p> 	
<p>OSRAM <small>Opto Semiconductors</small></p> <p>LED Soleriq P13 FWHM 21.0° Efficiency 94 % Peak intensity 2.370 cd/lm Required components: A.A.G. STUCCHI: 8502/G2</p>		
<p>OSRAM <small>Opto Semiconductors</small></p> <p>LED Soleriq S13 FWHM 20.0° Efficiency 94 % Peak intensity 2.580 cd/lm Required components: A.A.G. STUCCHI: 8502/G2</p>		

PHOTOMETRIC DATA (MEASURED):

OSRAM
Opto Semiconductors

LED Soleriq S13 Gen2
FWHM 20.0°
Efficiency 92 %
Peak intensity 2.400 cd/lm
Required components:
BJB: 47.319.2021

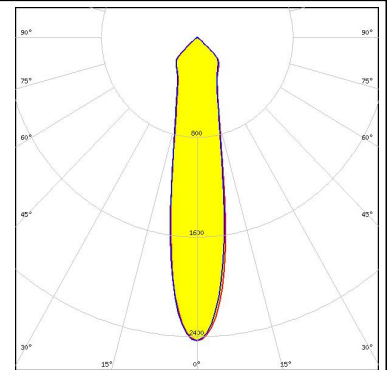

OSRAM
Opto Semiconductors

LED Soleriq S19
FWHM 23.0°
Efficiency 94 %
Peak intensity 2.160 cd/lm
Required components:
BJB: 47.319.2170

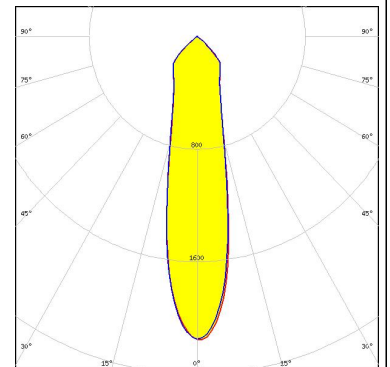
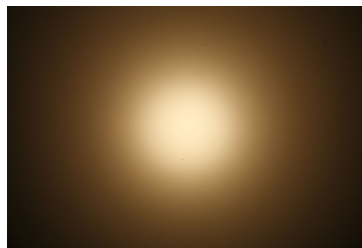

OSRAM
Opto Semiconductors

LED Soleriq S19
FWHM 23.0°
Efficiency 94 %
Peak intensity 2.200 cd/lm
Required components:
A.A.G. STUCCHI: 8503/G2

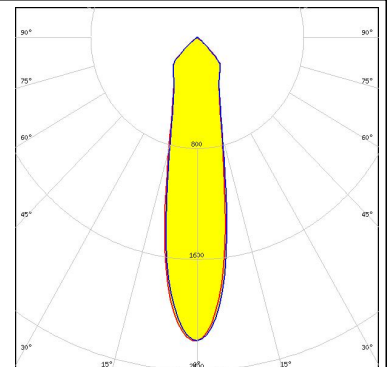
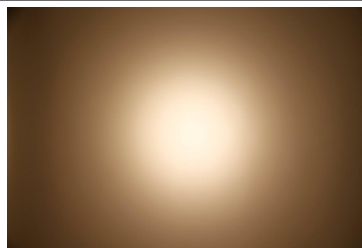

SAMSUNG

LED COB D Series LES 14.5 mm
FWHM 24.0°
Efficiency 93 %
Peak intensity 2.110 cd/lm
Required components:
BJB: 47.319.2021

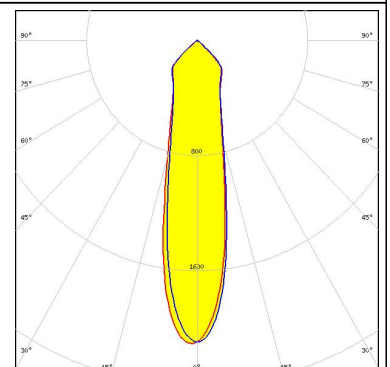
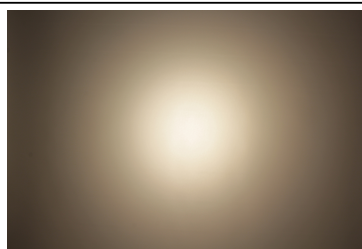

PHOTOMETRIC DATA (MEASURED):

SAMSUNG

LED COB D Series LES 14.5 mm
 FWHM 27.0°
 Efficiency 89 %
 Peak intensity 1.710 cd/lm
 Required components:
 F13671_ANGE-RZ-LENS
 A.A.G. STUCCHI: 8101/G2

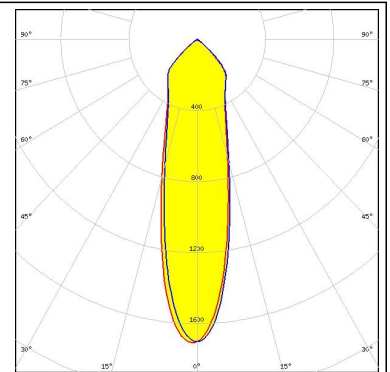

SAMSUNG

LED COB D Series LES 14.5 mm
 FWHM 27.0°
 Efficiency 89 %
 Peak intensity 1.710 cd/lm
 Required components:
 F13671_ANGE-RZ-LENS
 BJB: 47.319.2021

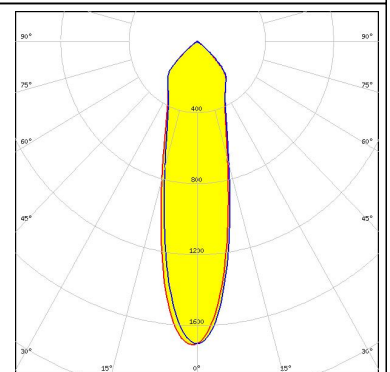
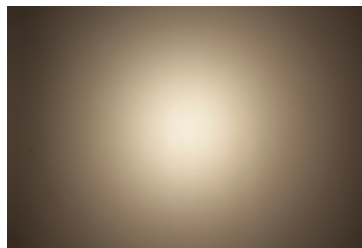

SAMSUNG

LED COB D Series LES 14.5 mm
 FWHM 24.0°
 Efficiency 93 %
 Peak intensity 2.110 cd/lm
 Required components:
 A.A.G. STUCCHI: 8101/G2

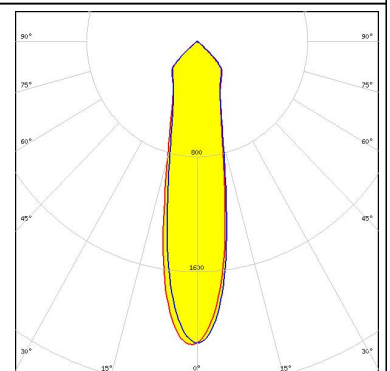
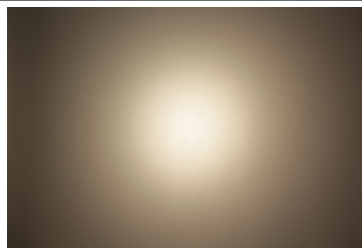

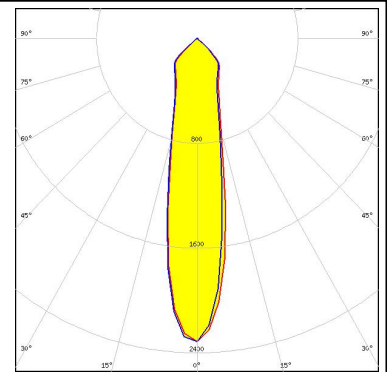
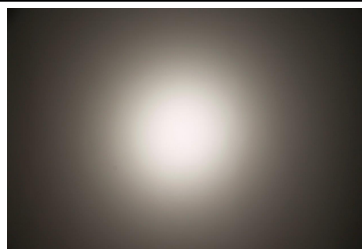

SEOUL SEMICONDUCTOR

LED ZC12/18
 FWHM 22.0°
 Efficiency 93 %
 Peak intensity 2.330 cd/lm
 Required components:
 A.A.G. STUCCHI: 8101/G2

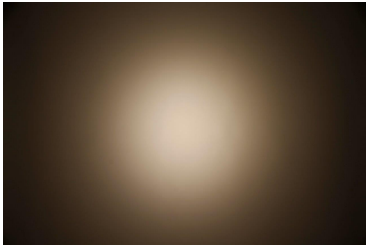
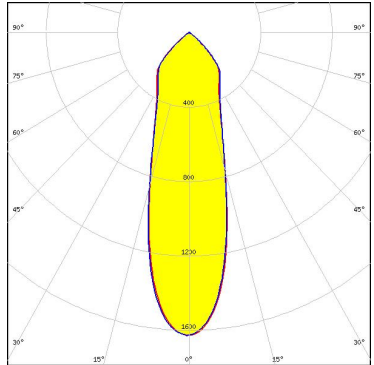
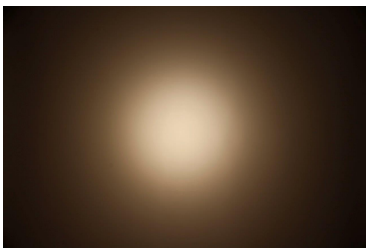
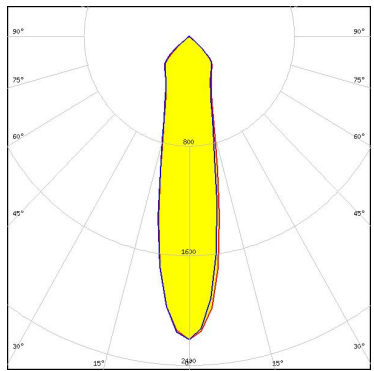

PHOTOMETRIC DATA (MEASURED):

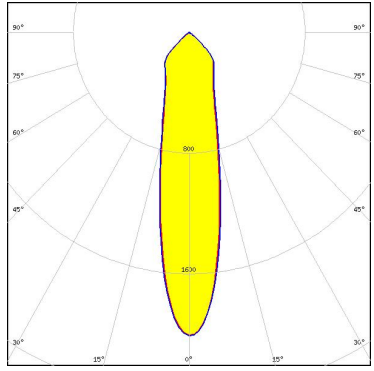
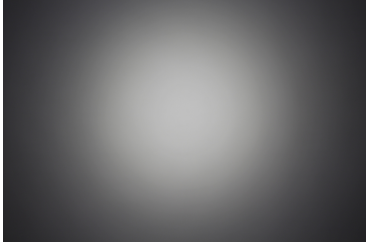
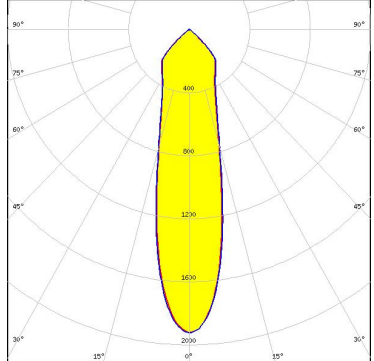
<p> SEUL SEMICONDUCTOR</p> <p>LED ZC25/40/60 FWHM 30.0° Efficiency 92 % Peak intensity 1.630 cd/lm Required components: A.A.G. STUCCHI: 8102/G2</p>		
<p>SHARP</p> <p>LED Mega Zenigata (GW6DME) FWHM 23.0° Efficiency 94 % Peak intensity 2.210 cd/lm Required components: A.A.G. STUCCHI: 8301/G2</p>		
<p>SHARP</p> <p>LED Tiger Zenigata (GWTGCBG4FD) FWHM 23.0° Efficiency 91 % Peak intensity 2.000 cd/lm Required components: F13671_ANGE-RZ-LENS BJB: 47.319.2051</p>		
<p>XICATO</p> <p>LED XTM - 19mm LES FWHM 25.0° Efficiency 93 % Peak intensity 1.900 cd/lm Required components: C15743_XTM-ADAPTER-50-B</p>		

PHOTOMETRIC DATA (SIMULATED):

CITIZEN

LED CLL04x/CLU04x
FWHM 22.0°
Efficiency 95 %
Peak intensity 3.100 cd/lm
Required components:
BJB: 47.319.2030

CITIZEN

LED CLU730/731
FWHM 16.0°
Efficiency 92 %
Peak intensity 5.490 cd/lm
Required components:
BJB: 47.319.2030

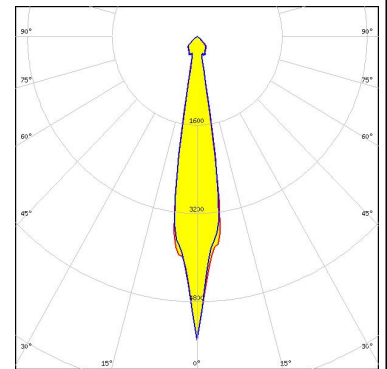

LUMILEDS

LED LUXEON K12
FWHM 15.0°
Efficiency %
Peak intensity cd/lm
Required components:
BJB: 47.319.2070

SAMSUNG

LED COB D Series LES 22 mm
FWHM 27.0°
Efficiency 90 %
Peak intensity 2.150 cd/lm
Required components:
BJB: 47.319.2030

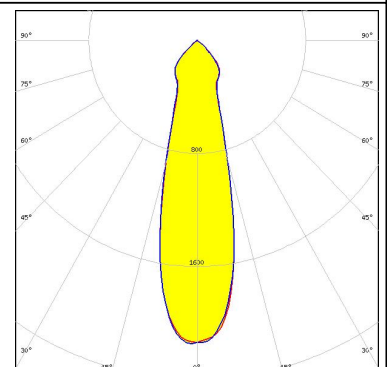

PHOTOMETRIC DATA (SIMULATED):

TRIDONIC

LED SLE G6 LES15 H D50
 FWHM 17.0°
 Efficiency 92 %
 Peak intensity 4.100 cd/lm
 Required components:

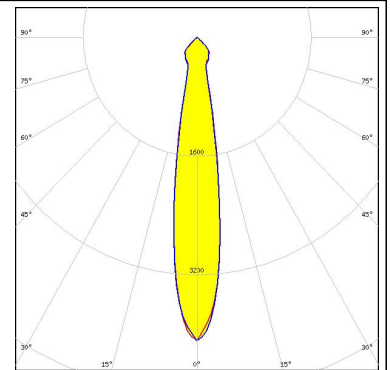

TRIDONIC

LED SLE G6 LES17 H
 FWHM 19.0°
 Efficiency 91 %
 Peak intensity 3.600 cd/lm
 Required components:

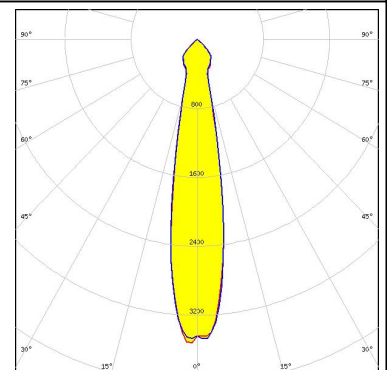

TRIDONIC

LED SLE G6 LES19 H
 FWHM 20.0°
 Efficiency 91 %
 Peak intensity 3.290 cd/lm
 Required components:

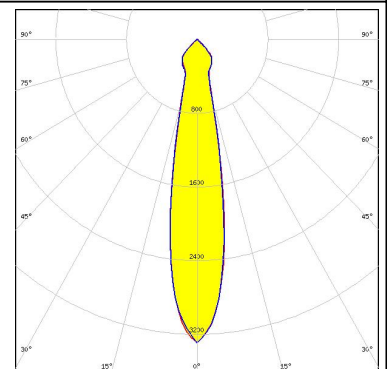

TRIDONIC

LED SLE G6 LES23 H
 FWHM 24.0°
 Efficiency 91 %
 Peak intensity 2.540 cd/lm
 Required components:

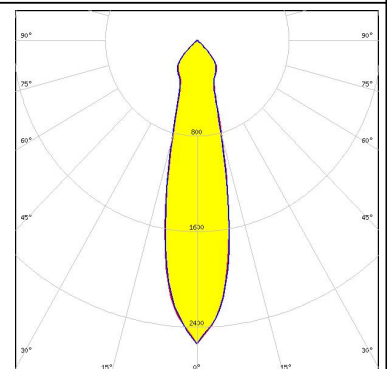

GENERAL INFORMATION:

NOTE: The typical beam angle will be changed by different color, chip size and chip position tolerance. The typical total beam angle is the full angle measured where the luminous intensity is half of the peak value.

Due to use of high power COB's with this product, special attention to proper thermal design is highly recommended. LEDiL has no liability for direct, indirect or consecutive damages arising from the LEDiL products being used outside of the recommended temperature range.

MATERIALS:

As part of our continuous research and improvement processes, and to ensure the best possible quality and availability of our products, LEDiL reserves the right to change material grades without notice.

PRODUCT DATA USER AGREEMENT AND DISCLAIMER:

The measured data in the provided downloadable LEDiL Product Datasheets and Mechanical 2D-Drawings is rounded and provided as reference for planning. LEDiL Oy's optical specifications have been verified by conducting performance testing of the products in accordance with the company's quality system. The reported data are averaged results of multiple measurements with typical variation. LEDiL Oy reserves the right to without prior notification make changes and improvements to its products.

LEDiL Oy assumes neither warranty, nor guarantee nor any other liability of any kind for the contents and correctness of the provided data. The provided data has been generated with highest diligence but the provided data may in reality not represent the complete possible variation range of all intrinsic parameters. Therefore, in certain cases a deviation from the provided data could occur.

LEDiL Oy reserves the right to undertake technical changes of its products without further notification which could lead to changes in the provided data. LEDiL Oy assumes no liability of any kind for the possible deviation from any provided data or any other damage resulting from the usage of the provided data.

The user agrees to this disclaimer and user agreement with the download or usage of the provided files.

LEDiL Oy

Joensuunkatu 13
FI-24240 SALO
Finland

LEDiL Inc.

228 West Page Street
Suite D
Sycamore IL 60178
USA

Local sales and technical support

[www.ledil.com/
where_to_buy](http://www.ledil.com/where_to_buy)

Shipping locations

Salo, Finland
Hong Kong, China

Distribution Partners

[www.ledil.com/
where_to_buy](http://www.ledil.com/where_to_buy)