

1 MDB1 Stößel

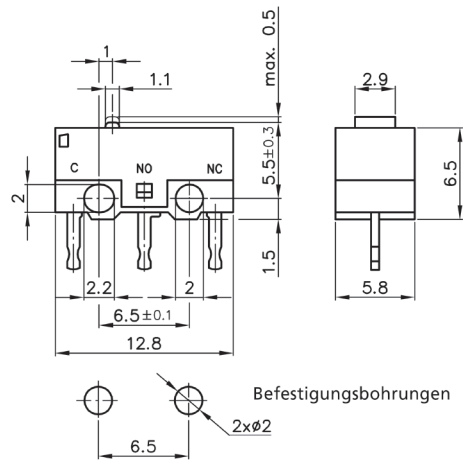
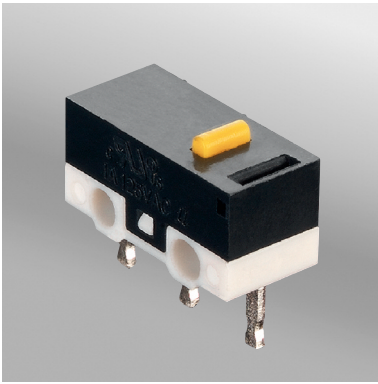

Blatffeder Kontaktsystem

- Microschalter Bauform D gem. DIN 41635
- funktionale Endkontrolle
- solide Konstruktion
- hochwertige Materialien
- sehr genaue Schaltlage

Microschalter, auch als Schnappschalter bezeichnet, werden vorrangig als Endschalter eingesetzt, sind aber auch für viele weitere Industrieanwendungen geeignet. Die Schaltgeschwindigkeit ist weitgehend unabhängig von der eigentlichen Betätigungsgeschwindigkeit. Die nach ISO 9001:2000 zertifizierte Fertigung und die 100% funktionale Endkontrolle garantieren die zuverlässige Funktion. Bei diesen Schaltern haben wir unsere langjährige Erfahrung und Zuverlässigkeit im Schalterbau eingebracht.

Leaf spring mechanism

- Micro switches design D acc. to DIN 41635
- functional final inspection and testing
- solid design
- high-quality materials
- very exact switching position

Micro switches, also known as snap action switches, are primarily used as limit switches, but are also suitable for many other industry applications. The actual switching speed is completely independent from the speed of operation. ISO 9001:2000 approved production together with 100% functional final inspection and testing guarantee reliable operation. These products reflect our long standing experience in design and production of high quality switches.

MECHANISCHE KENNWERTE	MECHANICAL DATA	
Mech. Lebensdauer	Mech. lifetime	100 000 Schaltungen / 100 000 actuations
Elektr. Lebensdauer	Electrical lifetime	min. 100 000 Schaltungen / min. 100 000 actuations
abhängig von Schaltleistung	depending on switching capacity	
Schaltleistung >1A	Switching capacity >1A	min. 10 000 Schaltungen / min. 10 000 actuations
Differenzweg	Movement differential	≤ 0,2mm
Vorlaufweg	Pretravel	≤ 0,5mm
Nachlaufweg	Overtravel	min. 0,2mm
Schaltpunkt	Operating position	5,5 ±0,3mm
Kontaktöffnungsweite	Contact opening	<3mm (μ)
SONSTIGE KENNWERTE	OTHER DATA	
Zulassungen	Approvals	cULus
MATERIAL	MATERIAL	
Sockel	Base	PBT (UL94-V0)
Kappe	Cap	PBT (UL94-V0)
Betätiger	Actuator	PBT (UL94-V0)
Anschlüsse	Terminals	CuZn versilbert / CuZn Ag plated
Kontakte	Contacts	AgNi
Kontaktgeber	Contact spring	CuBe

MDB1 Plunger

2 SCHALTLEISTUNG / RATING

0,1A 125VAC		Code: MDB1 01	3	4	5	6	7
0,3A 125VAC		Code: MDB1 02	3	4	5	6	7
0,5A 125VAC		Code: MDB1 03	3	4	5	6	7
1A 125VAC		Code: MDB1 04	3	4	5	6	7
3A 125VAC		Code: MDB1 05	3	4	5	6	7

3 BETÄTIGUNGSKRAFT / OPERATING FORCE

1,0N		Code: MDB1	2	B	4	5	6	7
1,5N		Code: MDB1	2	C	4	5	6	7
2,0N		Code: MDB1	2	D	4	5	6	7
2,5N		Code: MDB1	2	E	4	5	6	7



EMPFOLHENE KOMBINATIONEN / RECOMMENDED COMBINATIONS

	1,0N	1,5N	2,0N	2,5N
A 125VAC	■	■	■	■
0,3A 125VAC	■	■	■	■
0,5A 125VAC	■	■	■	■
1A 125VAC		■	■	■
3A 125VAC		■	■	■

4 UMGEBUNGSTEMPERATUR / AMBIENT TEMPERATURE

-10...+50°C	Code: MDB1	2	3	01	5	6	7
-------------	-------------------	---	---	-----------	---	---	---

5 KONTAKTANORDNUNG / CONTACT ARRANGEMENT

Öffner / Normally closed  Code: MDB1 2 3 4 A 6 7	Schließer / Normally open  Code: MDB1 2 3 4 B 6 7	Wechsler / Change-over Code: MDB1 2 3 4 C 6 7
--	---	--

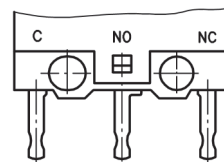
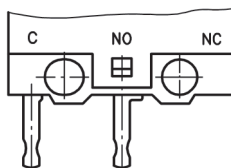
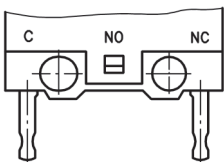

MDB1 Stößel

6 BETÄTIGER / ACTUATOR

Stößel / Plunger

Code: **MDB1** 2 3 4 5 **01** 7

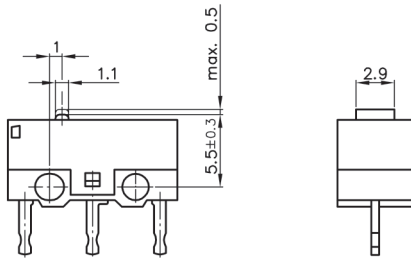

7 ANSCHLÜSSE / TERMINALS

LP-Anschluss / PCB terminal

Code: **MDB1** 2 3 4 5 6 **A**

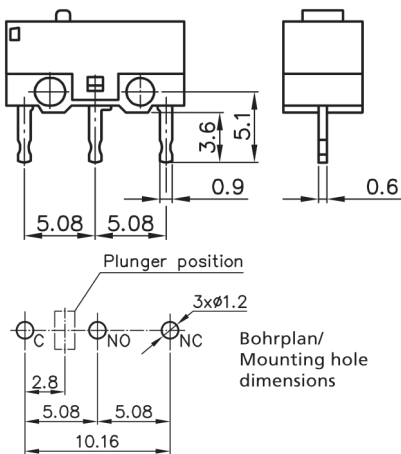

LP-Anschluss verschränkt / PCB terminal crimped

Code: **MDB1** 2 3 4 5 6 **B**

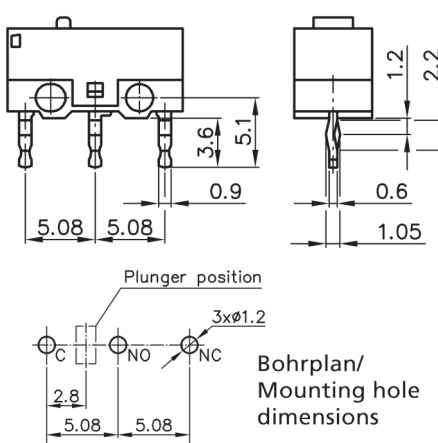

LP-Anschluss links / PCB terminal left

Code: **MDB1** 2 3 4 5 6 **C**

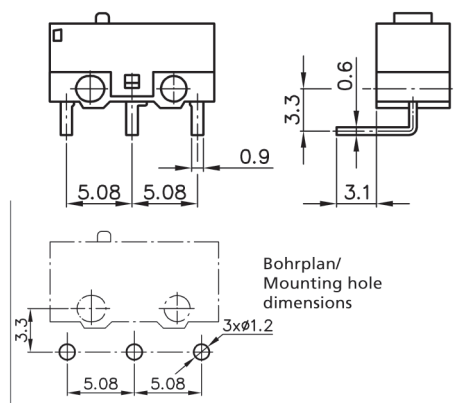

LP-Anschluss rechts / PCB terminal right

Code: **MDB1** 2 3 4 5 6 **D**

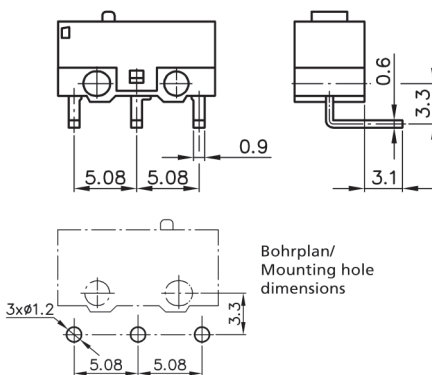

Lötöse / Solder terminal

Code: **MDB1** 2 3 4 5 6 **E**

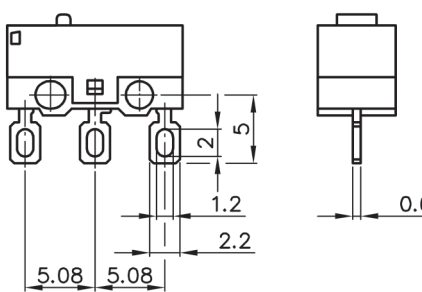

Lötöse (lang) / Solder terminal (long)

Code: **MDB1** 2 3 4 5 6 **F**

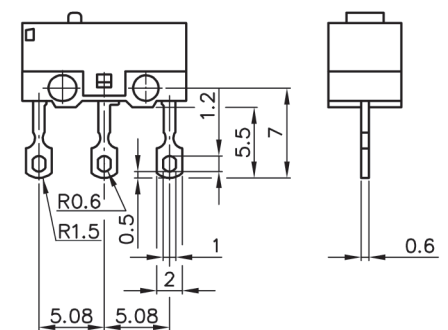

=auf Anfrage / upon request

MDB1 Plunger

ÜBERSICHT BETÄTIGER / WEGE / KRÄFTE
OVERVIEW ACTUATORS / TRAVEL / FORCES

	Code	Zusatzbetätigerlänge Actuator length		Betätigungskraft am Stößel Operating force on plunger		Betätigungskraft am Zusatzbetätiger Operating force on lever		Vorlaufweg Pretravel	Nachlaufweg Overtravel	Differenzweg Movement differential	Ruhestellung Free position	Schaltpunkt Operating position
		mm	≤ N	Code	≤ N	≤ mm	min. mm	≤ mm	≤ mm	≤ mm	mm	mm
Stößel	01	-	-	-	-	0,5	0,2	0,2	6,3	5,5 ±0,3		
Plunger		-	1,0	B	-							
		-	1,5	C	-							
		-	2,0	D	-							
		-	2,5	E	-							

1

MDB1 Hebel

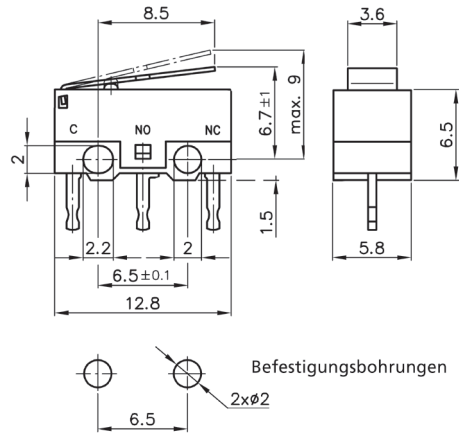
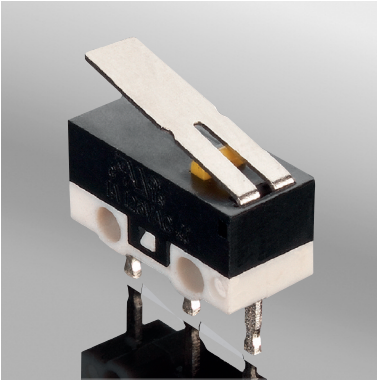

Blattfeder Kontaktsystem

- Microschalter Bauform D gem. DIN 41635
- funktionale Endkontrolle
- solide Konstruktion
- hochwertige Materialien
- sehr genaue Schaltlage

Microschalter, auch als Schnappschalter bezeichnet, werden vorrangig als Endschalter eingesetzt, sind aber auch für viele weitere Industrieanwendungen geeignet. Die Schaltgeschwindigkeit ist weitgehend unabhängig von der eigentlichen Betätigungsgeschwindigkeit. Die nach ISO 9001:2000 zertifizierte Fertigung und die 100% funktionale Endkontrolle garantieren die zuverlässige Funktion. Bei diesen Schaltern haben wir unsere langjährige Erfahrung und Zuverlässigkeit im Schalterbau eingebracht.

Leaf spring mechanism

- Micro switches design D acc. to DIN 41635
- functional final inspection and testing
- solid design
- high-quality materials
- very exact switching position

Micro switches, also known as snap action switches, are primarily used as limit switches, but are also suitable for many other industry applications. The actual switching speed is completely independent from the speed of operation. ISO 9001:2000 approved production together with 100% functional final inspection and testing guarantee reliable operation. These products reflect our long standing experience in design and production of high quality switches.

MECHANISCHE KENNWERTE	MECHANICAL DATA	
Mech. Lebensdauer	Mech. lifetime	100 000 Schaltungen / 100 000 actuations
Elektr. Lebensdauer	Electrical lifetime	min. 100 000 Schaltungen / min. 100 000 actuations
abhängig von Schaltleistung	depending on switching capacity	
Schaltleistung >1A	Switching capacity >1A	min. 10 000 Schaltungen / min. 10 000 actuations
Differenzweg	Movement differential	siehe Übersicht nächste Seite / please see overview next page
Vorlaufweg	Pretravel	siehe Übersicht nächste Seite / please see overview next page
Nachlaufweg	Overtravel	siehe Übersicht nächste Seite / please see overview next page
Schaltpunkt	Operating position	siehe Übersicht nächste Seite / please see overview next page
Kontaktöffnungsweite	Contact opening	<3mm (μ)
SONSTIGE KENNWERTE	OTHER DATA	
Zulassungen	Approvals	cULus
MATERIAL	MATERIAL	
Sockel	Base	PBT (UL94-V0)
Kappe	Cap	PBT (UL94-V0)
Betätiger	Actuator	PBT (UL94-V0)
Anschlüsse	Terminals	CuZn versilbert / CuZn Ag plated
Kontakte	Contacts	AgNi
Kontaktgeber	Contact spring	CuBe

MDB1 Hinge lever

2 SCHALTLEISTUNG / RATING

0,1A 125VAC		Code: MDB1 01	3	4	5	6	7
0,3A 125VAC		Code: MDB1 02	3	4	5	6	7
0,5A 125VAC		Code: MDB1 03	3	4	5	6	7
1A 125VAC		Code: MDB1 04	3	4	5	6	7
3A 125VAC		Code: MDB1 05	3	4	5	6	7

3 BETÄTIGUNGSKRAFT / OPERATING FORCE

1,0N		Code: MDB1 2 B	4	5	6	7
1,5N		Code: MDB1 2 C	4	5	6	7
2,0N		Code: MDB1 2 D	4	5	6	7
2,5N		Code: MDB1 2 E	4	5	6	7



EMPFOLHENE KOMBINATIONEN / RECOMMENDED COMBINATIONS

	1,0N	1,5N	2,0N	2,5N
A 125VAC	■	■	■	■
0,3A 125VAC	■	■	■	■
0,5A 125VAC	■	■	■	■
1A 125VAC		■	■	■
3A 125VAC		■	■	■

4 UMGEBUNGSTEMPERATUR / AMBIENT TEMPERATURE

-10...+50°C	Code: MDB1 2 3 01	5	6	7
-------------	--------------------------	---	---	---

5 KONTAKTANORDNUNG / CONTACT ARRANGEMENT

Öffner / Normally closed  Code: MDB1 2 3 4 A 6 7	Schließer / Normally open  Code: MDB1 2 3 4 B 6 7	Wechsler / Change-over Code: MDB1 2 3 4 C 6 7
---	--	---

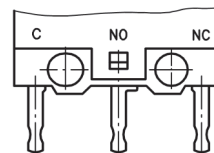
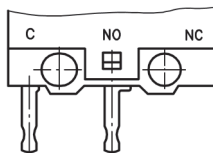
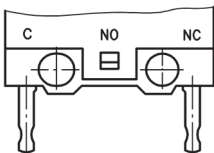

MDB1 Hebel

6 BETÄTIGER / ACTUATOR

Hebel 8,5mm / Hinge lever 8.5mm

Code: **MDB1** 2 3 4 5 **02** 7

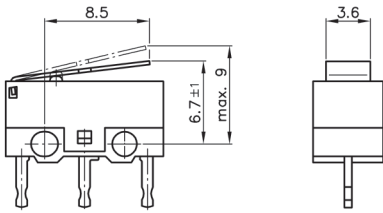

Hebel 10,6mm / Hinge lever 10.6mm

Code: **MDB1** 2 3 4 5 **03** 7

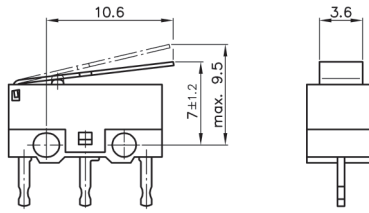

Hebel 15mm / Hinge lever 15mm

Code: **MDB1** 2 3 4 5 **04** 7

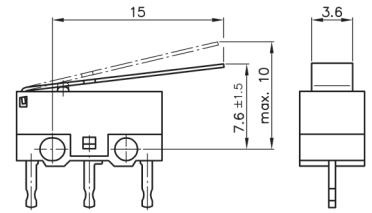

7 ANSCHLÜSSE / TERMINALS

LP-Anschluss / PCB terminal

Code: **MDB1** 2 3 4 5 6 **A**

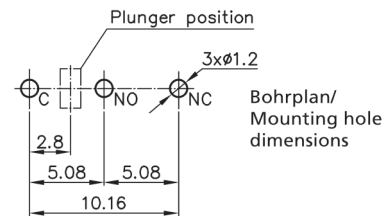
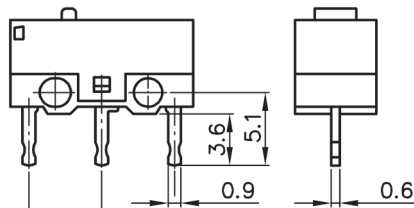

LP-Anschluss verschränkt / PCB terminal crimped

Code: **MDB1** 2 3 4 5 6 **B**

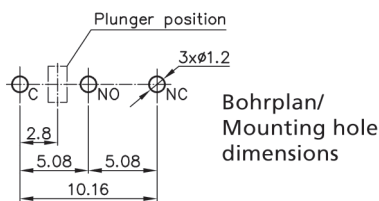
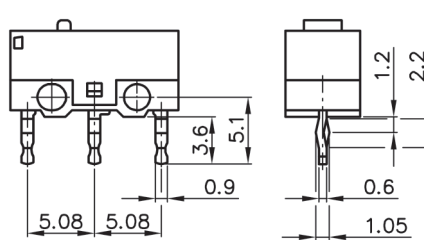

LP-Anschluss links / PCB terminal left

Code: **MDB1** 2 3 4 5 6 **C**

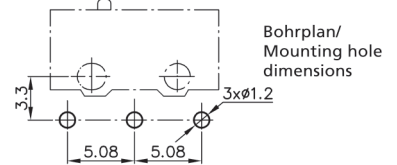
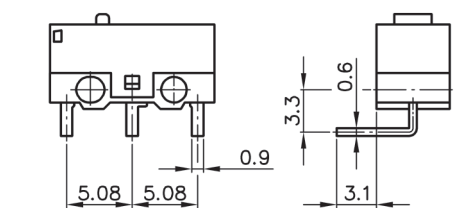

LP-Anschluss rechts / PCB terminal right

Code: **MDB1** 2 3 4 5 6 **D**

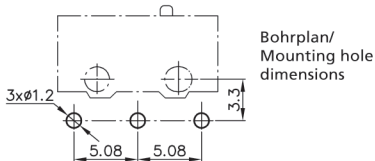
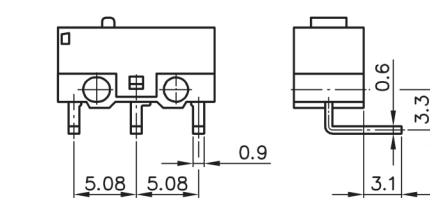

Lötöse / Solder terminal

Code: **MDB1** 2 3 4 5 6 **E**

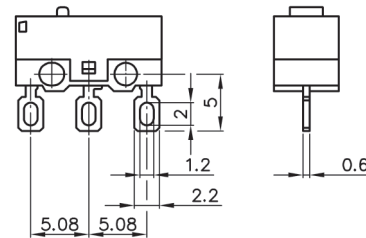

Lötöse (lang) / Solder terminal (long)

Code: **MDB1** 2 3 4 5 6 **F**

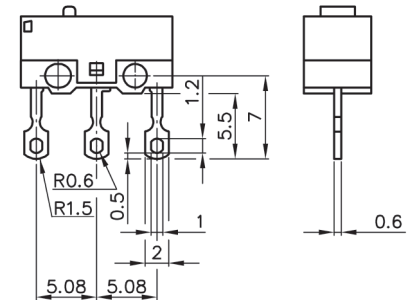

MDB1 Hinge lever

ÜBERSICHT BETÄTIGER / WEGE / KRÄFTE
OVERVIEW ACTUATORS / TRAVEL / FORCES

	Code	Zusatzbetätigerlänge Actuator length	Betätigungskraft am Stößel Operating force on plunger	Betätigungskraft am Zusatzbetätiger Operating force on lever	Vorlaufweg Pretravel	Nachlaufweg Overtravel	Differenzweg Movement differential	Ruhestellung Free position	Schaltpunkt Operating position	
	mm	≤ N	Code	≤ N	≤ mm	min. mm	≤ mm	≤ mm	mm	
Hebel 8,5mm	02	8,5	-	-	3,3	0,6	0,6	9	6,7 ±1	
Hinge lever 8,5mm			1,0	B						
			1,5	C						
			2,0	D						
			2,5	E						
	Code	mm	≤ N	Code	≤ N	≤ mm	min. mm	≤ mm	≤ mm	mm
Hebel 10,6mm	03	10,6	-	-	3,7	0,7	0,7	9,5	7 ±1,2	
Hinge lever 10,6mm			1,0	B						
			1,5	C						
			2,0	D						
			2,5	E						
	Code	mm	≤ N	Code	≤ N	≤ mm	min. mm	≤ mm	≤ mm	mm
Hebel 15mm	04	15	-	-	3,9	1	1	10	7,6 ±1,5	
Hinge lever 15mm			1,0	B						
			1,5	C						
			2,0	D						
			2,5	E						

1

MDB1 Rolle

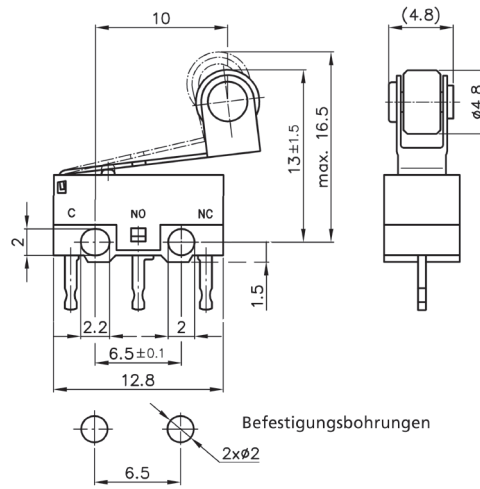

Blatffeder Kontaktsystem

- Microschalter Bauform D gem. DIN 41635
- funktionale Endkontrolle
- solide Konstruktion
- hochwertige Materialien
- sehr genaue Schaltlage

Microschalter, auch als Schnappschalter bezeichnet, werden vorrangig als Endschalter eingesetzt, sind aber auch für viele weitere Industrieanwendungen geeignet. Die Schaltgeschwindigkeit ist weitgehend unabhängig von der eigentlichen Betätigungsgeschwindigkeit. Die nach ISO 9001:2000 zertifizierte Fertigung und die 100% funktionale Endkontrolle garantieren die zuverlässige Funktion. Bei diesen Schaltern haben wir unsere langjährige Erfahrung und Zuverlässigkeit im Schalterbau eingebracht.

Leaf spring mechanism

- Micro switches design D acc. to DIN 41635
- functional final inspection and testing
- solid design
- high-quality materials
- very exact switching position

Micro switches, also known as snap action switches, are primarily used as limit switches, but are also suitable for many other industry applications. The actual switching speed is completely independent from the speed of operation. ISO 9001:2000 approved production together with 100% functional final inspection and testing guarantee reliable operation. These products reflect our long standing experience in design and production of high quality switches.

MECHANISCHE KENNWERTE	MECHANICAL DATA	
Mech. Lebensdauer	Mech. lifetime	100 000 Schaltungen / 100 000 actuations
Elektr. Lebensdauer	Electrical lifetime	min. 100 000 Schaltungen / min. 100 000 actuations
abhängig von Schaltleistung	depending on switching capacity	
Schaltleistung >1A	Switching capacity >1A	10 000 Schaltungen / 10 000 actuations
Differenzweg	Movement differential	siehe Übersicht nächste Seite / please see overview next page
Vorlaufweg	Pretravel	siehe Übersicht nächste Seite / please see overview next page
Nachlaufweg	Overtravel	siehe Übersicht nächste Seite / please see overview next page
Schaltpunkt	Operating position	siehe Übersicht nächste Seite / please see overview next page
Kontaktöffnungsweite	Contact opening	<3mm (μ)
SONSTIGE KENNWERTE	OTHER DATA	
Zulassungen	Approvals	cULus
MATERIAL	MATERIAL	
Sockel	Base	PBT (UL94-V0)
Kappe	Cap	PBT (UL94-V0)
Betätiger	Actuator	PBT (UL94-V0)
Anschlüsse	Terminals	CuZn versilbert / CuZn Ag plated
Kontakte	Contacts	AgNi
Kontaktgeber	Contact spring	CuBe

MDB1 Roller lever

2 SCHALTLEISTUNG / RATING

0,1A 125VAC		Code: MDB1 01	3	4	5	6	7
0,3A 125VAC		Code: MDB1 02	3	4	5	6	7
0,5A 125VAC		Code: MDB1 03	3	4	5	6	7
1A 125VAC		Code: MDB1 04	3	4	5	6	7
3A 125VAC		Code: MDB1 05	3	4	5	6	7

3 BETÄTIGUNGSKRAFT / OPERATING FORCE

1,0N		Code: MDB1 2 B	4	5	6	7
1,5N		Code: MDB1 2 C	4	5	6	7
2,0N		Code: MDB1 2 D	4	5	6	7
2,5N		Code: MDB1 2 E	4	5	6	7



EMPFOHLENE KOMBINATIONEN / RECOMMENDED COMBINATIONS

	1,0N	1,5N	2,0N	2,5N
A 125VAC	■	■	■	■
0,3A 125VAC	■	■	■	■
0,5A 125VAC	■	■	■	■
1A 125VAC		■	■	■
3A 125VAC		■	■	■

4 UMGEBUNGSTEMPERATUR / AMBIENT TEMPERATURE

-10...+50°C	Code: MDB1 2 3 01	5	6	7
-------------	--------------------------	---	---	---

5 KONTAKTANORDNUNG / CONTACT ARRANGEMENT

Öffner / Normally closed  Code: MDB1 2 3 4 A 6 7	Schließer / Normally open  Code: MDB1 2 3 4 B 6 7	Wechsler / Change-over Code: MDB1 2 3 4 C 6 7
---	--	---

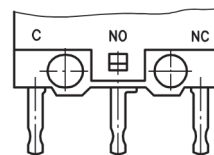
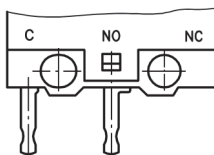
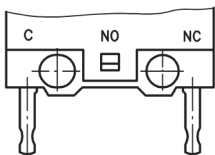

MDB1 Rolle

6 BETÄTIGER / ACTUATOR

Rolle 10mm / Roller lever 10mm

Code: **MDB1** 2 3 4 5 **05** 7

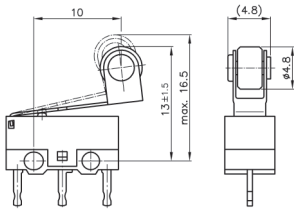

Simulierte Rolle 7,5mm / Simulated roller lever

Code: **MDB1** 2 3 4 5 **06** 7

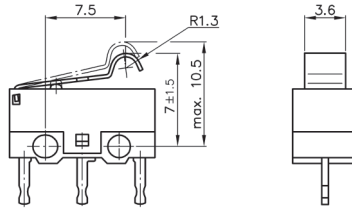

Simulierte Rolle 13,3mm / Simulated roller lever

Code: **MDB1** 2 3 4 5 **07** 7

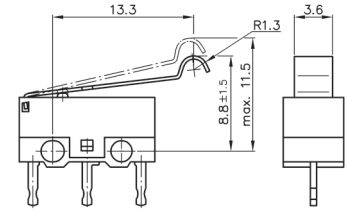

7 ANSCHLÜSSE / TERMINALS

LP-Anschluss / PCB terminal

Code: **MDB1** 2 3 4 5 6 **A**

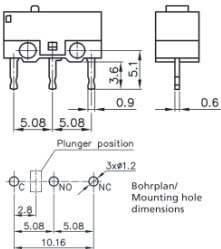

LP-Anschluss verschrängt / PCB terminal crimped

Code: **MDB1** 2 3 4 5 6 **B**

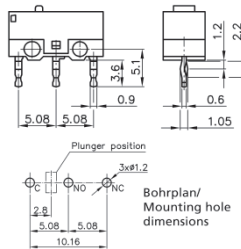

LP-Anschluss links / PCB terminal left

Code: **MDB1** 2 3 4 5 6 **C**

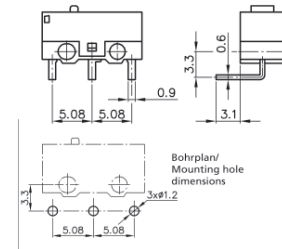

LP-Anschluss rechts / PCB terminal right

Code: **MDB1** 2 3 4 5 6 **D**

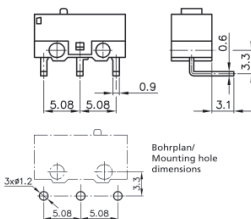

Lötöse / Solder lug

Code: **MDB1** 2 3 4 5 6 **E**

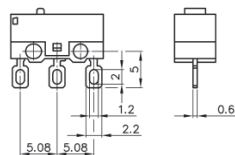

Lötöse (lang) / Solder terminal (long)

Code: **MDB1** 2 3 4 5 6 **F**

