

IEC Appliance Inlet C14 with Filter, Fuseholder 1- or 2-pole (5x20 mm or 6.3x32 mm), optional Voltage Selector (step switch)

Standard- or Medical-Filter



V-Lock



with voltage selector



without voltage selector



Description

- Panel Mount :
Screw-on mounting from front side
- 4 Functions :
Appliance Inlet Protection class I , Fuseholder with interchangeable fuse drawer for Fuse-links 5x20 mm or 6.3x32 mm , with or without voltage selector (step switch) , Line filter in standard and medical version
- Quick connect terminals 4.8 x 0.8 mm

Unique Selling Proposition

- Multifunctional power entry module
- Suitable for various fuses
- Highly resistant since fully potted
- V-Lock cord retaining

Approvals

- VDE Certificate Number: 40004665 (FKO, FKP, FKQ, FKR)
- UL File Number: E72928 (FKO, FKP, FKQ, FKR)

Characteristics

- All single elements are already wired
- The fuse drawer "Fingergrip" can be removed by hand
- Suitable for use in equipment according to IEC/UL 60950
- Suitable for use in medical equipment according to IEC/UL 60601-1

Other versions on request

- Variant with notch for V-Lock mating Cordsets

References

Alternative: version without line filter [KEC](#)
Alternative: Standard version

Weblinks

[pdf datasheet](#), [html-datasheet](#), [General Product Information](#), [RoHS](#), [CHINA-RoHS](#), [REACH](#), [Distributor-Stock-Check](#), [Accessories](#), [Detailed request for product](#)

Newly available variants corresponding to V-Lock mating cordset. The connector is equipped with a notch intended for use with the latching cordset. The cord latching system prevents against accidental removal of the cordset.

Technical Data

Ratings IEC	1 - 10A @ Ta 40 °C / 250VAC; 50Hz	appliance inlet/-outlet	C14 acc. to IEC 60320-1, UL 498, CSA C22.2 no. 42 (for cold conditions) pin-temperature 70 °C, 10A, Protection Class I
Ratings UL/CSA	1 - 10A @ Ta 40 °C / 125VAC; 60Hz	Fuseholder	1 or 2 pole, Shocksafe category PC2 acc. to IEC 60127-6, for fuse-links 5 x 20 or 6.3 x 32 mm
Leakage Current	standard < 0.5 mA (250 V / 60Hz) medical < 5 µA (250 V / 60 Hz)	Rated Power Acceptance @ Ta 23 °C	5 x 20: 2.5W (1 pole)/ 2W (2-pole) per pole 6.3 x 32: 3.15W (1 pole)/ 2.5W (2-pole) per pole
Dielectric Strength	> 1.7 kVDC between L-N > 2.7 kVDC between L/N-PE Test voltage (2 sec)	Power Acceptance @ Ta > 23°C	Admissible power acceptance at higher ambient temperature see derating curves
Allowable Operation Temperature	-25 °C to 85 °C	Voltage Selector	optional, step, 3 pos.
Climatic Category	25/085/21 acc. to IEC 60068-1	Line Filter	Standard and Medical Version, IEC 60939, UL 1283, CSA C22.2 no. 8 Technical Details
IP-Protection	from front side IP 40 acc. to IEC 60529	MTBF	> 1'700'000h acc. to MIL-HB-217 F
Protection Class	Suitable for appliances with protection class I acc. to IEC 61140		
Terminal	Quick connect terminals 4.8 x 0.8 mm		
Panel Thickness s	Screw: max 8 mm Mounting screw torque max 0.5Nm		
Material: Housing	Thermoplastic, black, UL 94V-0		

Detailed information on product approvals, code requirements, usage instructions and detailed test conditions can be looked up in [General Product Information](#)

Dimension

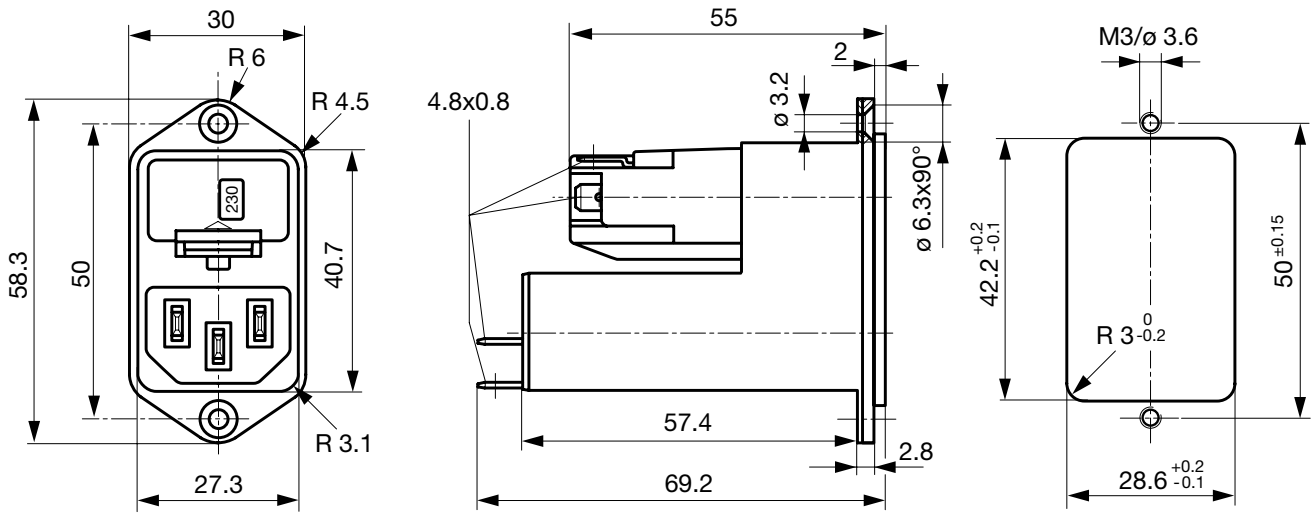

Technical Data of Filter-Components

Rated Current [A]	Filter-Type	Inductances L [mH]	Capacitance CX [nF]	Capacitance CY [nF]	R [M Ω]
1	Standard Version	2 x 10	68	2.2	-
2	Standard Version	2 x 4	68	2.2	-
4	Standard Version	2 x 1.5	68	2.2	-
6	Standard Version	2 x 0.8	68	2.2	-
10	Standard Version	2 x 0.3	68	2.2	-
1	Medical Version (M5)	2 x 10	68	-	1
2	Medical Version (M5)	2 x 4	68	-	1
4	Medical Version (M5)	2 x 1.5	68	-	1
6	Medical Version (M5)	2 x 0.8	68	-	1
10	Medical Version (M5)	2 x 0.3	68	-	1
10	Standard and Medical Version	2 x 0.3	68	2.2	1

Diagrams

Standard version with voltage selector

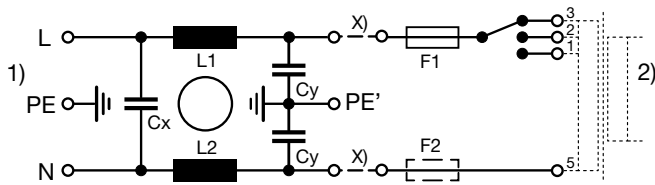

x) external connection to be made by the customer

- 1) Line
- 2) Load

Medical version (M5) with voltage selector

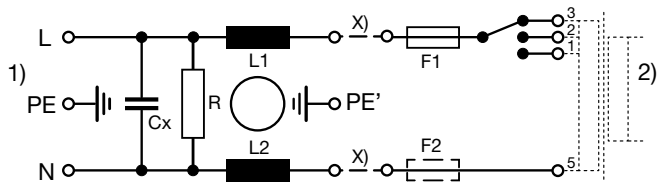

x) external connection to be made by the customer

- 1) Line
- 2) Load

Derating Curves

Fuses

5 x 20 mm (1-pole)

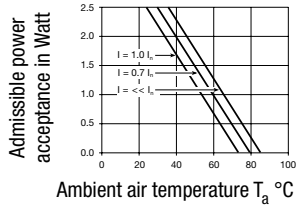

Fuses

5 x 20 mm (2-pole, per pole)

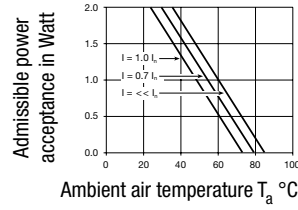

Fuses

6.3 x 32 mm (1-pole)

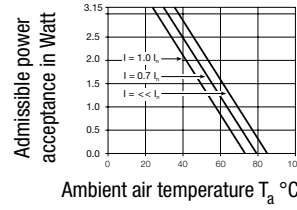

Fuses

6.3 x 32 mm (2-pole, per pole)

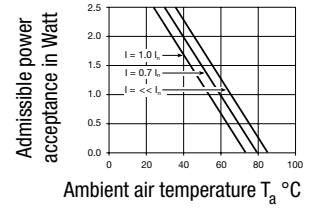

Attenuation Loss

Standard version

--- 50Ω differential mode — 50Ω common mode

1 A

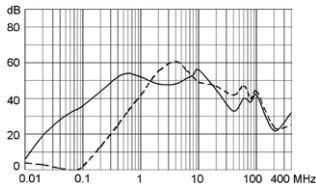

2 A

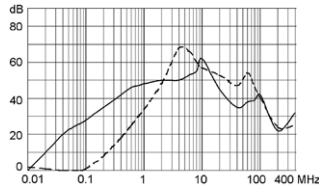

4 A

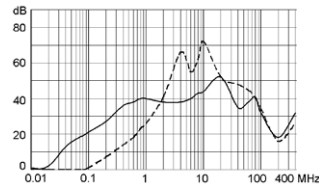

6 A

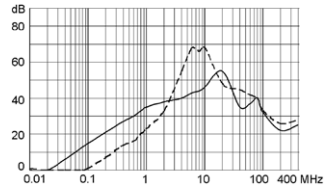

10 A

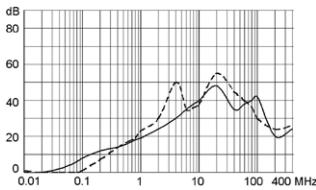

Medical version (M5)

1 A

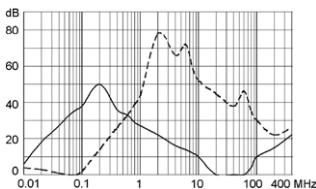

2 A

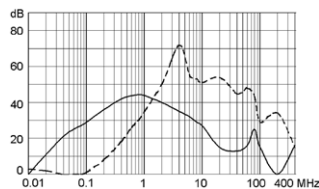

4 A

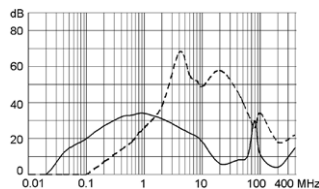

6 A

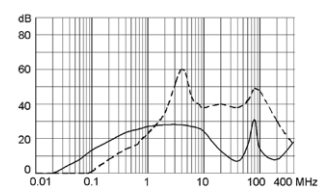

10 A

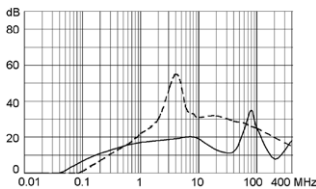

All Variants

Rated Current [A]	Filter-Type	Fuseholder	Voltage Selector	V-Lock	Order Number
1	Standard Version	1-pole	-		4303.5011
2	Standard Version	1-pole	-		4303.5012
4	Standard Version	1-pole	-		4303.5013
6	Standard Version	1-pole	-		4303.5014

Rated Current [A]	Filter-Type	Fuseholder	Voltage Selector	V-Lock	Order Number
10	Standard Version	1-pole	-		4303.5015
1	Standard Version	1-pole	3 pos.		4303.5031
2	Standard Version	1-pole	3 pos.		4303.5032
4	Standard Version	1-pole	3 pos.		4303.5033
6	Standard Version	1-pole	3 pos.		4303.5034
10	Standard Version	1-pole	3 pos.		4303.5035
1	Standard Version	2-pole	-		4303.5001
2	Standard Version	2-pole	-		4303.5002
4	Standard Version	2-pole	-		4303.5003
6	Standard Version	2-pole	-		4303.5004
10	Standard Version	2-pole	-		4303.5005
1	Standard Version	2-pole	3 pos.		4303.5021
2	Standard Version	2-pole	3 pos.		4303.5022
4	Standard Version	2-pole	3 pos.		4303.5023
6	Standard Version	2-pole	3 pos.		4303.5024
10	Standard Version	2-pole	3 pos.		4303.5025
1	Medical Version (M5)	2-pole	3 pos.		4303.5221
2	Medical Version (M5)	2-pole	3 pos.		4303.5223
4	Medical Version (M5)	2-pole	3 pos.		4303.5225
6	Medical Version (M5)	2-pole	3 pos.		4303.5227
10	Medical Version (M5)	2-pole	3 pos.	●	4303.5209.21
10	Medical Version (M5)	2-pole	3 pos.		4303.5229

Most Popular.

Availability for all products can be searched real-time:<http://www.schurter.com/en/Stock-Check/Stock-Check-SCHURTER>

Packaging unit 10 Pcs

Required Accessory

Description

Fusedrawer 3
Fusedrawer for Fuse Links 5x20 mm resp. 6.3x32 mm



Fingergrip, 5 x 20, 2-pole, Voltage Selector	4303.2014.00
Fingergrip, 5 x 20, 2-pole, Voltage Selector, 100, 120, 220, 240	4303.2014.01
Fingergrip, 5 x 20, 2-pole, Voltage Selector, 110, 150, 220	4303.2014.02
Fingergrip, 5 x 20, 2-pole, Voltage Selector, 110, 220	4303.2014.03

...

Accessories

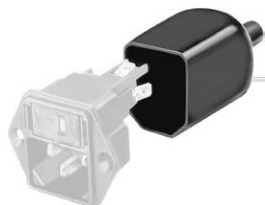

Assorted Covers
Rear Cover

0859.0072



Cord retaining kits
Cord retaining strain relief

Flat head, A

4700.0001

Mating Outlets/Connectors

Category / Description

Appliance Outlet Overview complete



IEC Appliance Outlet F, Screw-on Mounting, Front Side, Solder Terminal

4787

IEC Appliance Outlet F, Snap-in Mounting, Front Side, Solder or Quick-connect Terminal

4788

IEC Appliance Outlet F or H, Screw-on Mounting, Front Side, Solder, PCB or Quick-connect Terminal

5091

[Appliance Outlet further types to KFC](#)

Connector Overview complete



4782 Mounting: Power Cord, 3 x 1 mm² / 3 x 18 AWG, Cable, Connector: IEC C13

4782

4022 Mounting: Power Supply Cord, 3 x 1.5 mm², Screw clamps, Connector: IEC C13

4022

4785 Mounting: Power Cord, 3 x 1 mm² / 3 x 18 AWG, Cable, Connector: IEC C13

4785

4300-06 Mounting: Power Cord, 3 x 1 mm² / 3 x 18 AWG, Cable, Connector: IEC C13

4300-06

4012 Mounting: Power Supply Cord, 3 x 1.5 mm², Screw clamps, Connector: IEC C13

4012

[Connector further types to KFC](#)

...

Mating Outlets/Connectors shuttered



Power Cord Overview complete

VAC13KS, Overview, diverse Connector IEC C13, cord end:

VAC13KS

[Power Cord further types to KFC](#)