



VARIABLE GAIN AMPLIFIER 5 - 12 GHz

Typical Applications

The HMC996LP4E is ideal for:

- Point-to-Point Radio
- Point-to-Multi-Point Radio
- EW & ECM Subsystems
- X-Band Radar
- Test Equipment & Sensors

Features

- Wide Gain Control Range: 22 dB
- Single Control Voltage: -1 to -4.5V
- Output IP3 @ Max Gain: +34 dBm
- Output P1dB: +22 dBm
- Low Noise Figure 2dB @ max gain
- No External Matching
- 24 Lead 4x4 mm SMT Package: 16 mm²

Functional Diagram

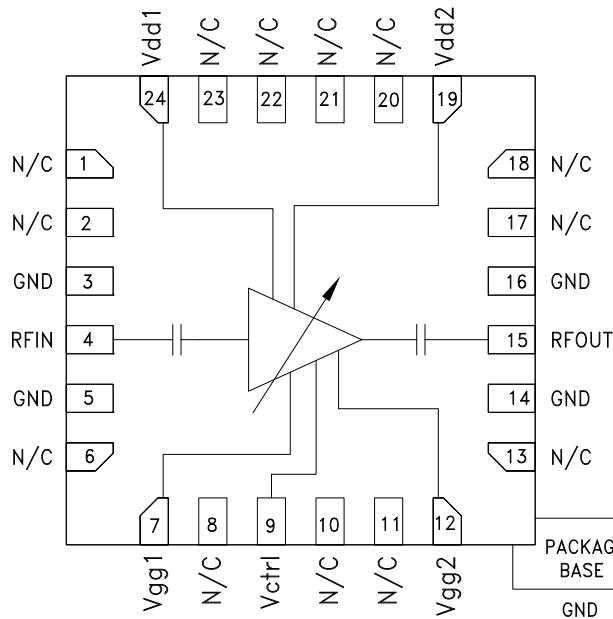

General Description

The HMC996LP4E is a GaAs PHEMT MMIC analog variable gain amplifier and / or driver amplifier which operates between 5 and 12 GHz. Ideal for microwave radio applications, the amplifier provides up to 18.5 dB of gain, output P1dB of up to +23 dBm, and up to +34 dBm of output IP3 at maximum gain, while requiring only 170 mA from a +5V supply. Gain control voltage pin (Vctrl) is provided to allow variable gain control up to 22 dB. Gain flatness is excellent making the HMC996LP4E ideal for EW, ECM and radar applications. The HMC996LP4E is housed in a RoHS compliant 4 x 4 mm QFN leadless package and is compatible with high volume surface mount manufacturing.

Electrical Specifications, $T_A = +25^\circ\text{C}$, $V_{dd1, 2} = 5\text{V}$, $V_{ctrl} = -4.5\text{V}$, $I_{dd} = 120\text{ mA}^*$

Parameter	Min.	Typ.	Max.	Min.	Typ.	Max.	Units
Frequency Range		5 - 8.5		8.5 - 12			GHz
Gain	16	18.5		13	16		dB
Gain Flatness		± 0.5			± 1		dB
Gain Variation Over Temperature		0.006			0.006		dB/°C
Gain Control Range	15	22		15	20		dB
Noise Figure		2.5			2		dB
Input Return Loss		17			9		dB
Output Return Loss		23			7		dB
Output Power for 1 dB Compression (P1dB)	19	22		20	23		dBm
Saturated Output Power (Psat)		23			24		dBm
Output Third Order Intercept (IP3)		34			34		dBm
Total Supply Current (Idd)		120			120		mA

*Set Vctrl = -4.5V and then adjust Vgg1, 2 between -2V to 0V to achieve Idd = 120 mA typical.

HMC996* PRODUCT PAGE QUICK LINKS

Last Content Update: 02/23/2017

COMPARABLE PARTS

View a parametric search of comparable parts.

EVALUATION KITS

- HMC996LP4E Evaluation Board

DOCUMENTATION

Data Sheet

- HMC996 Data Sheet

TOOLS AND SIMULATIONS

- HMC996 S-Parameter

REFERENCE MATERIALS

Quality Documentation

- Package/Assembly Qualification Test Report: LP3, LP4, LP5 & LP5G (QTR: 2014-00145)
- Semiconductor Qualification Test Report: PHEMT-F (QTR: 2013-00269)

DESIGN RESOURCES

- HMC996 Material Declaration
- PCN-PDN Information
- Quality And Reliability
- Symbols and Footprints

DISCUSSIONS

View all HMC996 EngineerZone Discussions.

SAMPLE AND BUY

Visit the product page to see pricing options.

TECHNICAL SUPPORT

Submit a technical question or find your regional support number.

DOCUMENT FEEDBACK

Submit feedback for this data sheet.



**VARIABLE GAIN AMPLIFIER
5 - 12 GHz**

Gain vs. Control Voltage Range

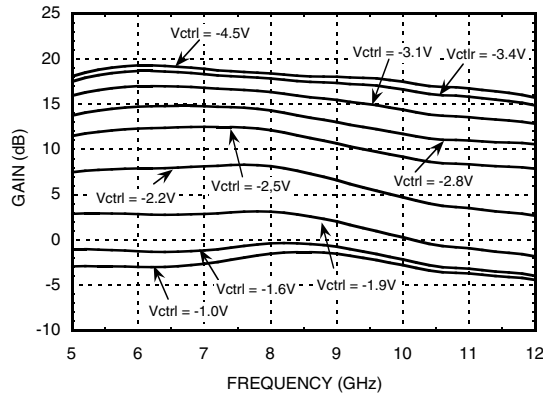

Gain vs. Control Voltage

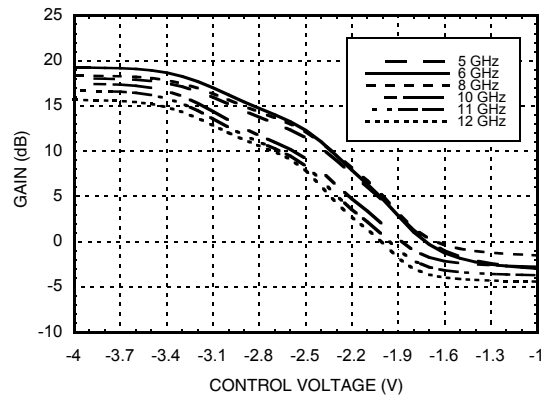

Broadband Gain & Return Loss

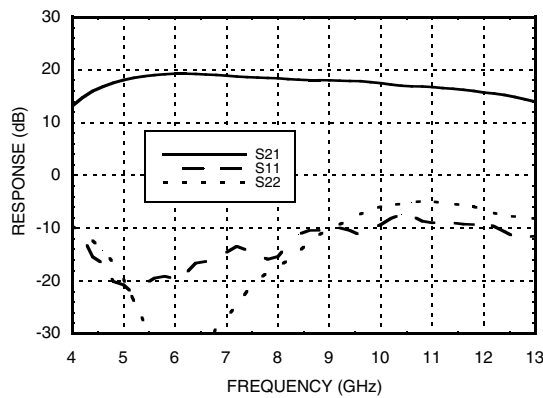

Gain vs. Temperature

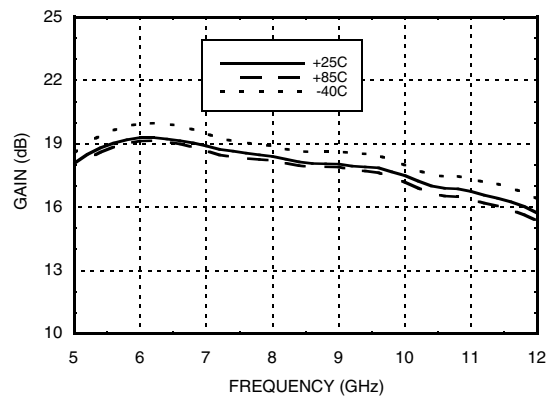

Input Return Loss vs. Temperature

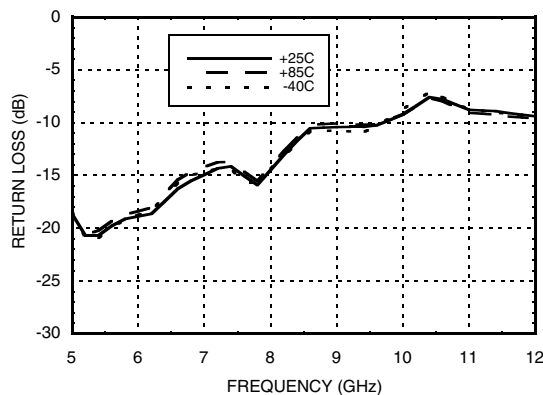

Output Return Loss vs. Temperature

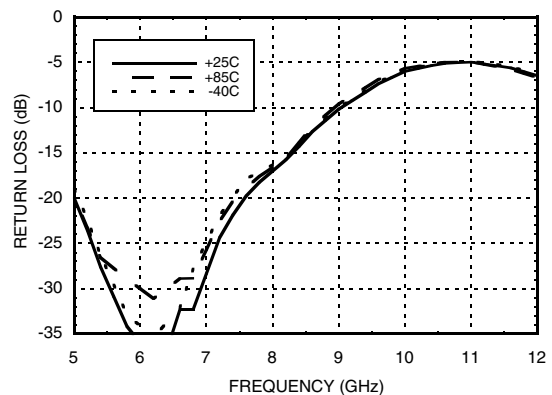



**VARIABLE GAIN AMPLIFIER
5 - 12 GHz**

VARIABLE GAIN AMPLIFIER - SMT

Input Return Loss @ Control Voltage Extreme

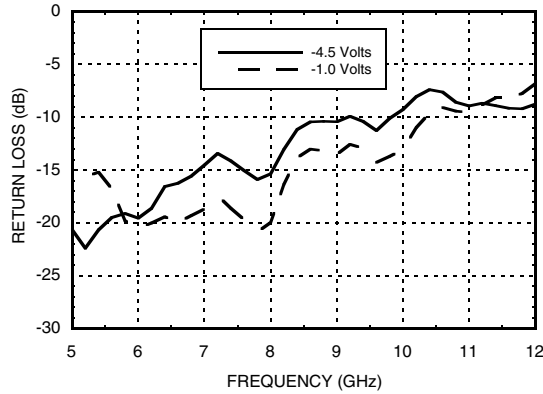

Output Return Loss @ Control Voltage Extreme

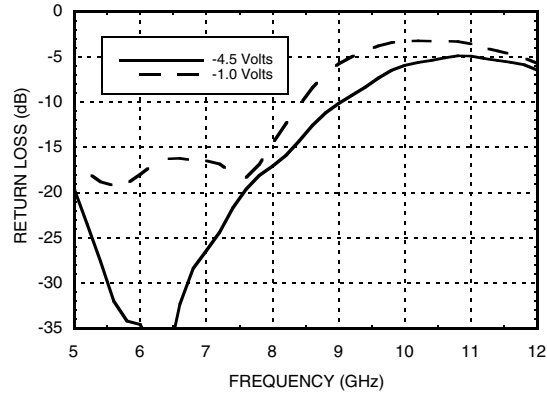

Noise Figure vs. Temperature

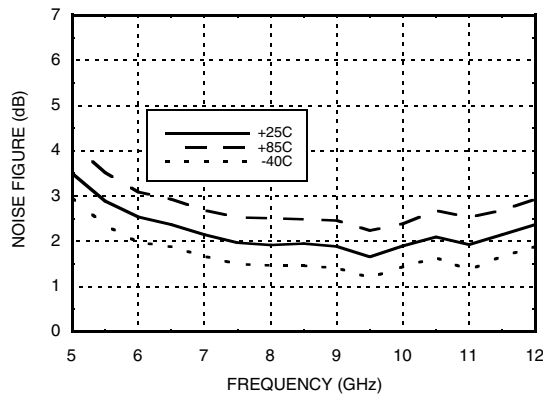

Noise Figure vs. Control Voltage

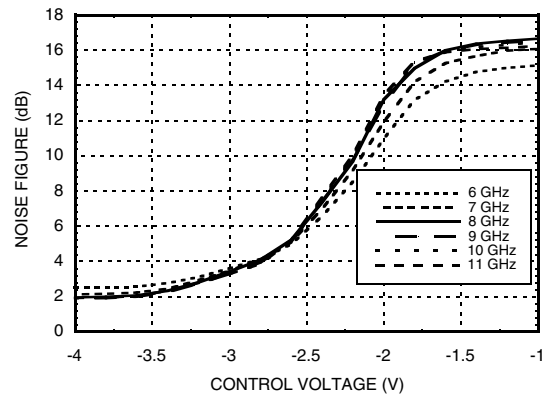

P1dB vs. Temperature

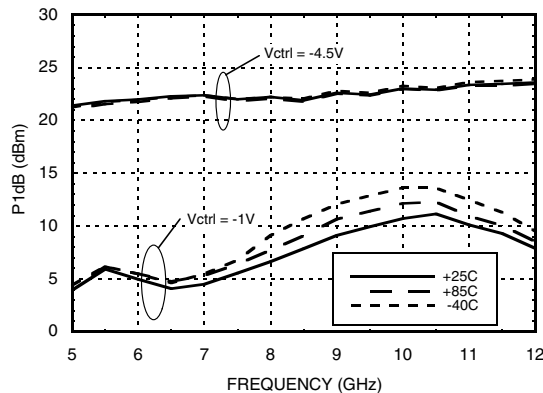

Psat vs. Temperature

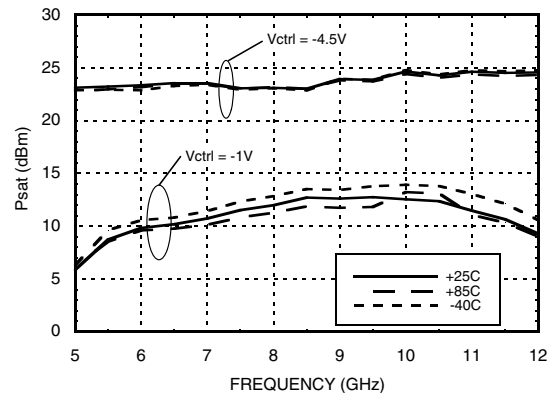

Information furnished by Analog Devices is believed to be accurate and reliable. However, no responsibility is assumed by Analog Devices for its use, nor for any infringements of patents or other rights of third parties that may result from its use. Specifications subject to change without notice. No license is granted by implication or otherwise under any patent or patent rights of Analog Devices. Trademarks and registered trademarks are the property of their respective owners.

For price, delivery, and to place orders: Analog Devices, Inc., One Technology Way, P.O. Box 9106, Norwood, MA 02062-9106 Phone: 781-329-4700 • Order online at www.analog.com Application Support: Phone: 1-800-ANALOG-D



**VARIABLE GAIN AMPLIFIER
5 - 12 GHz**

Reverse Isolation vs. Temperature

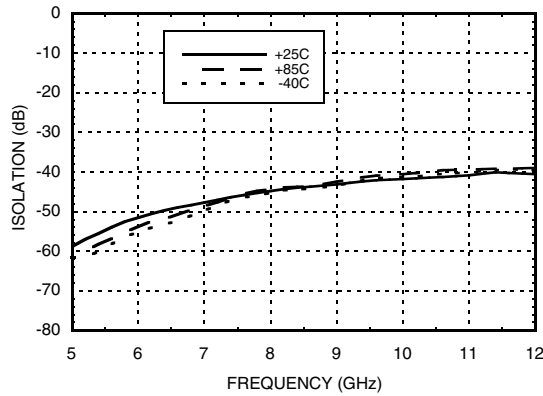

Output IP3 vs. Temperature

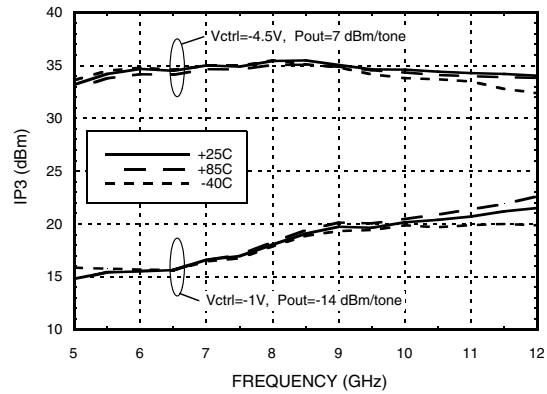

IP3 and Gain @ 6 GHz, Pin = -10 dBm

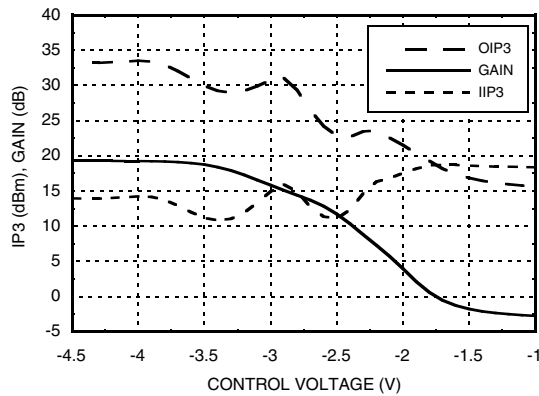

IP3 and Gain @ 8 GHz, Pin = -10 dBm

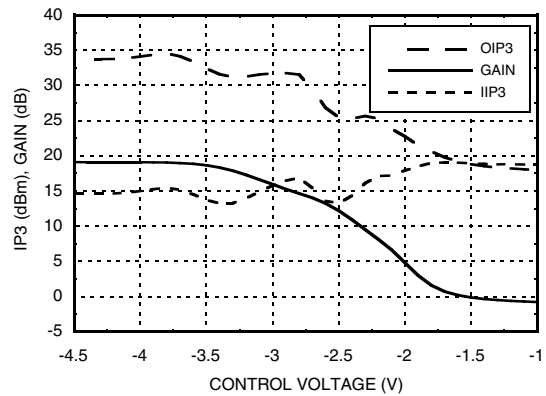

IP3 and Gain @ 10 GHz, Pin = -10 dBm

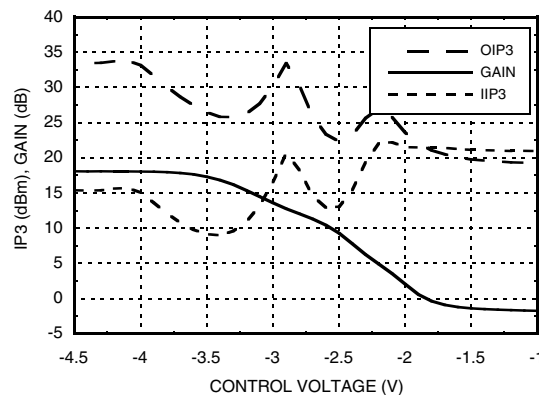



VARIABLE GAIN AMPLIFIER 5 - 12 GHz

Absolute Maximum Ratings

Drain Bias Voltage (Vdd1, 2)	+5.5V
Gate Bias Voltage (Vgg1, 2)	-3 to 0V
Gain Control Voltage (Vctrl)	-5 to 0V
RF Power Input	+20 dBm
Channel Temperature	175 °C
Continuous Pdiss (T = 85 °C) (derate 11.5 mW/°C above 85 °C) [1]	1.03 W
Thermal Resistance (Channel to ground paddle)	86.7 °C/W
Storage Temperature	-65 to +150 °C
Operating Temperature	-40 to +85 °C
ESD Sensitivity (HBM)	Class 0 Passed 150V

Bias Voltage

Vdd1,2(V)	Idd Total (mA)
+5V	120 mA
Vgg1,2 (V)	Igg Total (mA)
0V to -2V	<0.1 mA



**ELECTROSTATIC SENSITIVE DEVICE
OBSERVE HANDLING PRECAUTIONS**

Outline Drawing

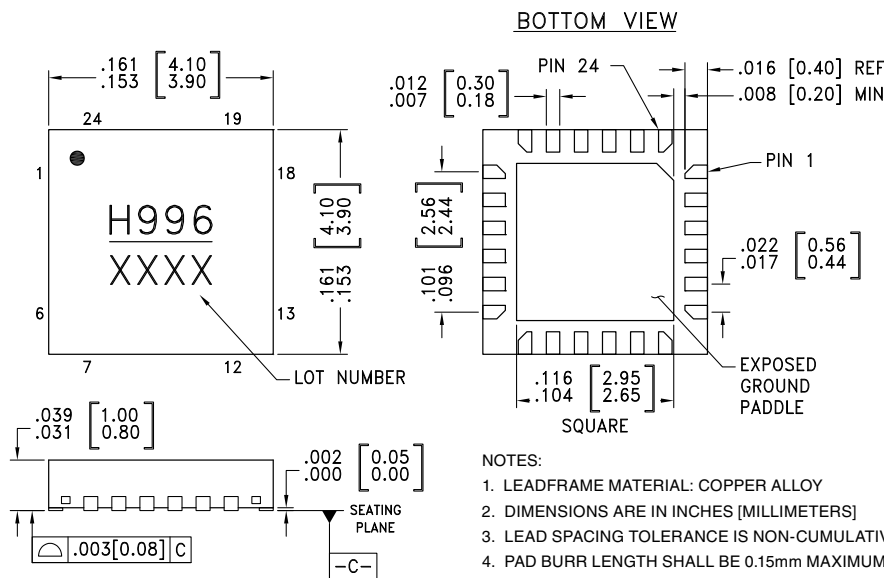

NOTES:

- LEADFRAME MATERIAL: COPPER ALLOY
- DIMENSIONS ARE IN INCHES [MILLIMETERS]
- LEAD SPACING TOLERANCE IS NON-CUMULATIVE.
- PAD BURR LENGTH SHALL BE 0.15mm MAXIMUM.
PAD BURR HEIGHT SHALL BE 0.05mm MAXIMUM.
- PACKAGE WARP SHALL NOT EXCEED 0.05mm.
- ALL GROUND LEADS AND GROUND PADDLE MUST BE SOLDERED TO PCB RF GROUND.
- REFER TO HITTITE APPLICATION NOTE FOR SUGGESTED LAND PATTERN.

Package Information

Part Number	Package Body Material	Lead Finish	MSL Rating	Package Marking [2]
HMC996LP4E	RoHS-compliant Low Stress Injection Molded Plastic	100% matte Sn	MSL1 [1]	H996 XXXX

[1] Max peak reflow temperature of 260 °C

[2] 4-Digit lot number XXXX



Pin Descriptions

Pin Number	Function	Description	Interface Schematic
1, 2, 6, 8, 10, 11, 13, 17, 18, 20, 21, 22, 23	N/C	The pins are not connected internally; however all data shown herein was measured with these pins connected to RF/DC ground externally	
3, 5, 14, 16	GND	These pins and exposed ground paddle must be connected to RF/DC ground.	
4	RFIN	This pad is AC coupled and matched to 50 Ohm.	
7, 12	Vgg1, 2	Gate control for amplifier. Adjust voltage to achieve typical I _{dd} . Please follow "MMIC Amplifier Biasing Procedure" application note.	
9	Vctrl	Gain control Voltage for the amplifier. See assembly diagram for required external components.	
15	RFOUT	This pad is AC coupled and matched to 50 Ohm.	
19, 24	Vdd1, 2	Drain Bias Voltage for the amplifier. See assembly diagram for required external components	



**VARIABLE GAIN AMPLIFIER
5 - 12 GHz**

Application Circuit

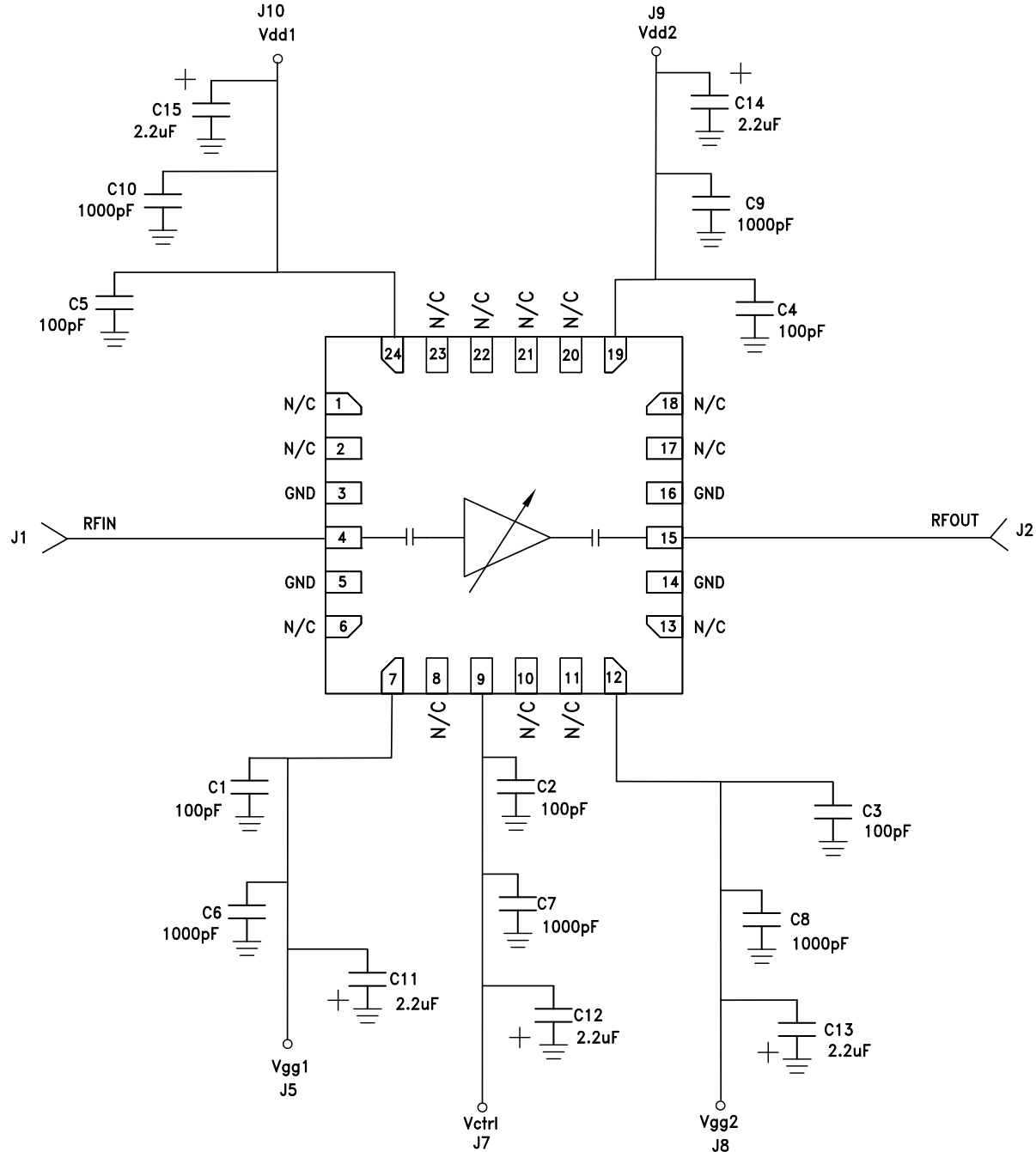

Information furnished by Analog Devices is believed to be accurate and reliable. However, no responsibility is assumed by Analog Devices for its use, nor for any infringements of patents or other rights of third parties that may result from its use. Specifications subject to change without notice. No license is granted by implication or otherwise under any patent or patent rights of Analog Devices. Trademarks and registered trademarks are the property of their respective owners.

For price, delivery, and to place orders: Analog Devices, Inc., One Technology Way, P.O. Box 9106, Norwood, MA 02062-9106 Phone: 781-329-4700 • Order online at www.analog.com Application Support: Phone: 1-800-ANALOG-D



Evaluation PCB

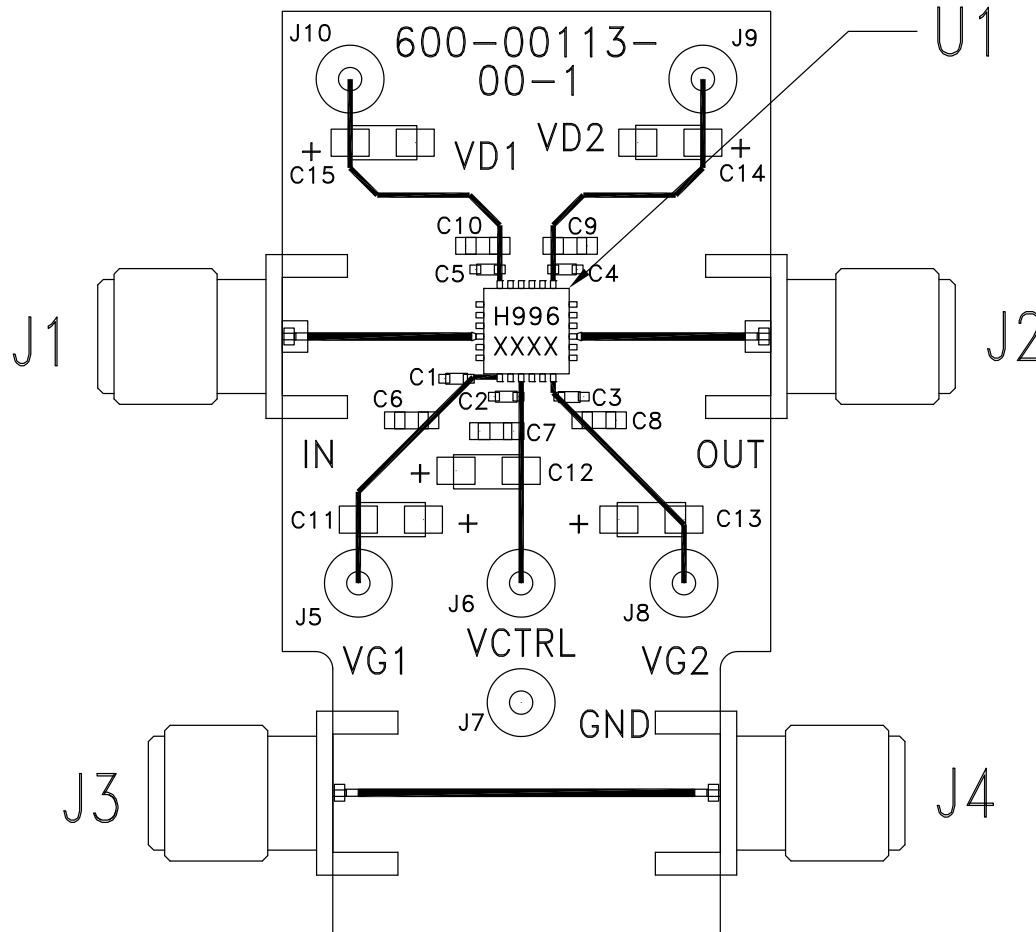

List of Materials for Evaluation PCB

EVAL01-HMC996LP4E [1]

Item	Description
J1, J4	PCB Mount SMA RF Connectors
J5 - J10	DC Pin
C1 - C5	100 pF Capacitor, 0402 Pkg.
C6 - C10	1000 pF Capacitor, 0603 Pkg.
C11 - C15	2.2 μF Capacitor, CASE A
U1	HMC996LP4E Variable Gain Amplifier
PCB [2]	600-00113-00 Evaluation PCB

[1] Reference this number when ordering complete evaluation PCB

[2] Circuit Board Material: Arlon 25FR

The circuit board used in the application should use RF circuit design techniques. Signal lines should have 50 Ohm impedance while the package ground leads and exposed paddle should be connected directly to the ground plane similar to that shown. A sufficient number of via holes should be used to connect the top and bottom ground planes. The evaluation circuit board shown is available from Hit-tite upon request.