

T2800D



Expertise Applied | Answers Delivered

Triacs

Silicon Bidirectional Thyristors

Designed primarily for full-wave ac control applications, such as light dimmers, motor controls, heating controls and power supplies.

Features

- Blocking Voltage to 400 V
- All Diffused and Glass Passivated Junctions for Greater Parameter Uniformity and Stability
- Small, Rugged, Thermowatt Construction for Low Thermal Resistance, High Heat Dissipation and Durability
- Four Quadrant Gating
- Pb-Free Package is Available

MAXIMUM RATINGS (T_J = 25°C unless otherwise noted)

Rating	Symbol	Value	Unit
Peak Repetitive Off-State Voltage (Note 1) (T _J = -40 to +125°C, Gate Open)	V _{DRM} , V _{RRM}	400	V
On-State RMS Current (All Conduction Angles, T _C = +80°C)	I _{T(RMS)}	8.0	A
Peak Non-Repetitive Surge Current (One Full Cycle Sine Wave, 60 Hz, T _J = +80°C)	I _{TSM}	100	A
Circuit Fusing Consideration (t = 8.3 ms)	I ² t	40	A ² s
Peak Gate Power (Pulse Width = 10 μs, T _C = +80°C)	P _{GM}	16	W
Average Gate Power (t = 8.3 ms, T _C = +80°C)	P _{G(AV)}	0.35	W
Peak Gate Current (Pulse Width = 10 μs, T _C = +80°C)	I _{GM}	4.0	A
Operating Junction Temperature Range	T _J	-40 to +125	°C
Storage Temperature Range	T _{stg}	-40 to +150	°C

Stresses exceeding Maximum Ratings may damage the device. Maximum Ratings are stress ratings only. Functional operation above the Recommended Operating Conditions is not implied. Extended exposure to stresses above the Recommended Operating Conditions may affect device reliability.

1. V_{DRM} and V_{RRM} for all types can be applied on a continuous basis. Blocking voltages shall not be tested with a constant current source such that the voltage ratings of the devices are exceeded.

Littelfuse.com

TRIACS 8 AMPERES RMS, 400 VOLTS

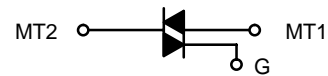

MARKING DIAGRAM

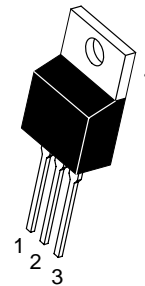

TO-220AB
CASE 221A
STYLE 4

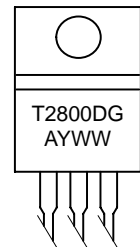

A = Assembly Location
Y = Year
WW = Work Week
G = Pb-Free Package

PIN ASSIGNMENT

Pin	Assignment
1	Main Terminal 1
2	Main Terminal 2
3	Gate
4	Main Terminal 2

ORDERING INFORMATION

Device	Package	Shipping
T2800D	TO-220AB	500 Units/Box
T2800DG	TO-220AB (Pb-Free)	500 Units/Box

T2800D

THERMAL CHARACTERISTICS

Characteristic	Symbol	Value	Unit
Thermal Resistance, Junction-to-Case	$R_{\theta JC}$	2.2	$^{\circ}C/W$
Maximum Lead Temperature for Soldering Purposes 1/8" from Case for 10 Sec	T_L	260	$^{\circ}C$

ELECTRICAL CHARACTERISTICS ($T_C = 25^{\circ}C$ unless otherwise noted; Electricals apply in both directions)

Characteristic	Symbol	Min	Typ	Max	Unit
----------------	--------	-----	-----	-----	------

OFF CHARACTERISTICS

Peak Repetitive Blocking Current ($V_D = \text{Rated } V_{DRM}, V_{RRM}; \text{ Gate Open}$)	I_{DRM}, I_{RRM}	-	-	10	μA
		-	-	2.0	mA
					$T_C = 25^{\circ}C$
					$T_C = 100^{\circ}C$

ON CHARACTERISTICS

Peak On-State Voltage (Note 2) ($I_T = \pm 30 \text{ A Peak}$)	V_{TM}	-	1.7	2.0	V
Gate Trigger Current (Continuous dc) ($V_D = 12 \text{ Vdc}, R_L = 100 \Omega$)	I_{GT}				mA
	MT2(+), G(+)	-	10	25	
	MT2(+), G(-)	-	20	60	
	MT2(-), G(-)	-	15	25	
	MT2(-), G(+)	-	30	60	
Gate Trigger Voltage (Continuous dc) (All Quadrants) ($V_D = 12 \text{ Vdc}, R_L = 100 \Omega$)	V_{GT}	-	1.25	2.5	V
Gate Non-Trigger Voltage (Continuous dc) ($V_D = 12 \text{ V}, R_L = 100 \Omega, T_C = 100^{\circ}C$)	V_{GD}	0.2	-	-	V
Holding Current ($V_D = 12 \text{ Vdc}, \text{ Initiating Current} = \pm 200 \text{ mA}, \text{ Gate Open}$)	I_H	-	15	30	mA
Gate Controlled Turn-On Time ($V_D = \text{Rated } V_{DRM}, I_T = 10 \text{ A}, I_{GT} = 80 \text{ mA}, \text{ Rise Time} = 0.1 \mu s$)	t_{gt}	-	1.6	-	μs

DYNAMIC CHARACTERISTICS

Critical Rate-of-Rise of Commutation Voltage ($V_D = \text{Rated } V_{DRM}, I_{T(RMS)} = 8 \text{ A}, \text{ Commutating } di/dt = 4.1 \text{ A/ms}, \text{ Gate Unenergized}, T_C = 80^{\circ}C$)	$dv/dt(c)$	-	10	-	$V/\mu s$
Critical Rate-of-Rise of Off-State Voltage ($V_D = \text{Rated } V_{DRM}, \text{ Exponential Voltage Rise, Gate Open}, T_C = 100^{\circ}C$)	dv/dt	60	-	-	$V/\mu s$

2. Pulse Test: Pulse Width $\leq 2.0 \text{ ms}$, Duty Cycle $\leq 2\%$.

Voltage Current Characteristic of Triacs (Bidirectional Device)

Symbol	Parameter
V_{DRM}	Peak Repetitive Forward Off State Voltage
I_{DRM}	Peak Forward Blocking Current
V_{RRM}	Peak Repetitive Reverse Off State Voltage
I_{RRM}	Peak Reverse Blocking Current
V_{TM}	Maximum On State Voltage
I_H	Holding Current

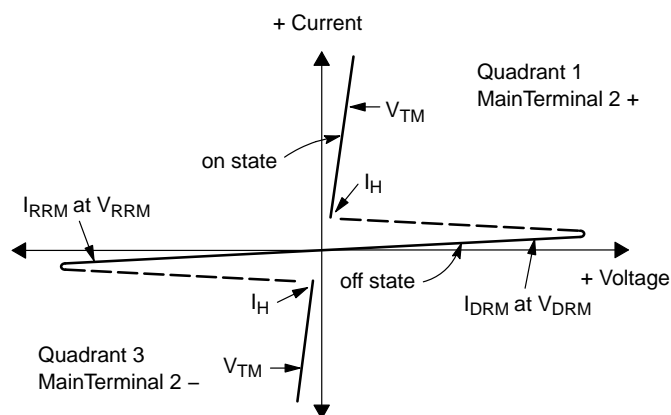

T2800D

Quadrant Definitions for a Triac

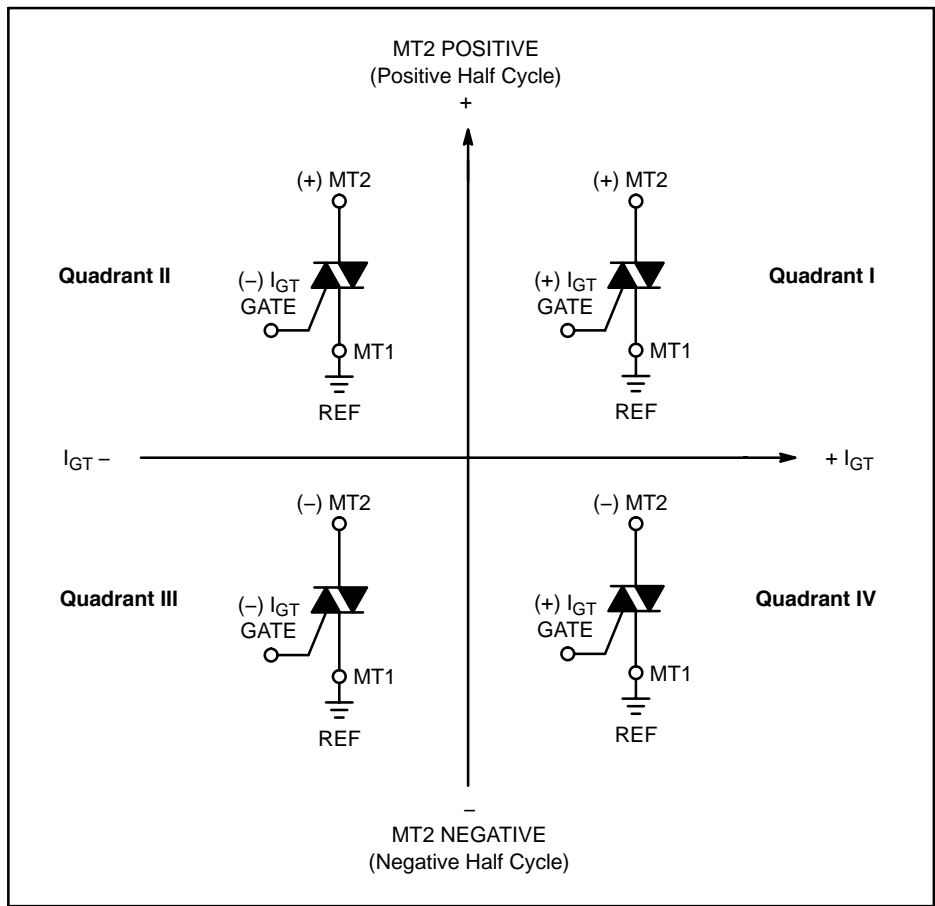

All polarities are referenced to MT1.
With in-phase signals (using standard AC lines) quadrants I and III are used.

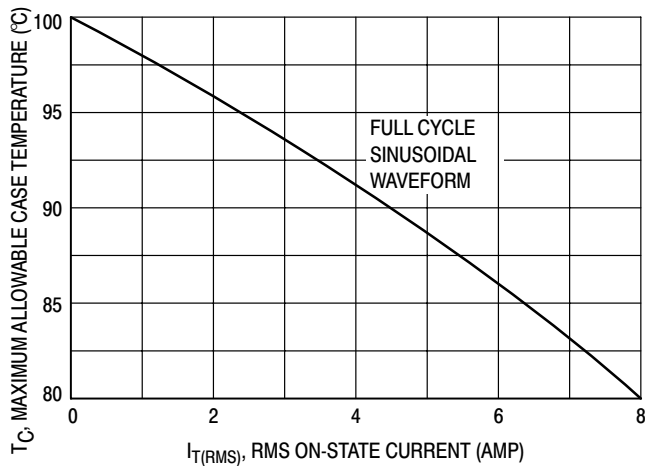

Figure 1. Current Derating

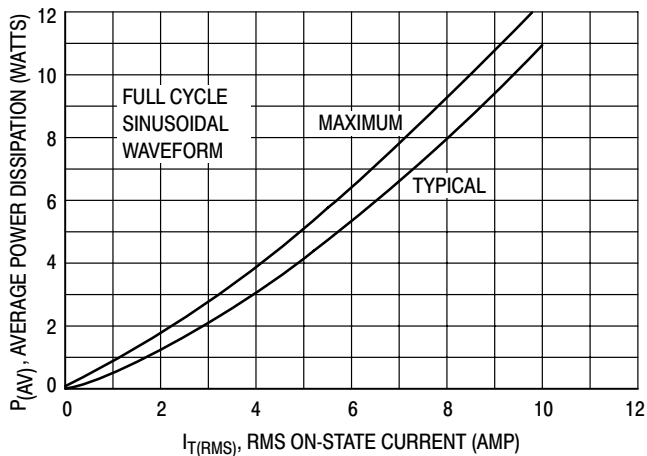
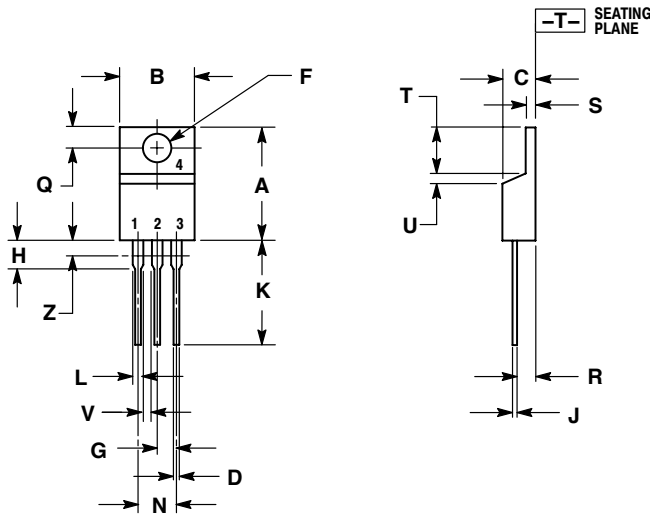

Figure 2. Power Dissipation

T2800D

PACKAGE DIMENSIONS

TO-220 CASE 221A-07 ISSUE AA



- NOTES:
1. DIMENSIONING AND TOLERANCING PER ANSI Y14.5M, 1982.
 2. CONTROLLING DIMENSION: INCH.
 3. DIMENSION Z DEFINES A ZONE WHERE ALL BODY AND LEAD IRREGULARITIES ARE ALLOWED.

DIM	INCHES		MILLIMETERS	
	MIN	MAX	MIN	MAX
A	0.570	0.620	14.48	15.75
B	0.380	0.405	9.66	10.28
C	0.160	0.190	4.07	4.82
D	0.025	0.035	0.64	0.88
F	0.142	0.147	3.61	3.73
G	0.095	0.105	2.42	2.66
H	0.110	0.155	2.80	3.93
J	0.014	0.022	0.36	0.55
K	0.500	0.562	12.70	14.27
L	0.045	0.060	1.15	1.52
N	0.190	0.210	4.83	5.33
Q	0.100	0.120	2.54	3.04
R	0.080	0.110	2.04	2.79
S	0.045	0.055	1.15	1.39
T	0.235	0.255	5.97	6.47
U	0.000	0.050	0.00	1.27
V	0.045	---	1.15	---
Z	---	0.080	---	2.04

- STYLE 4:
1. MAIN TERMINAL 1
 2. MAIN TERMINAL 2
 3. GATE
 4. MAIN TERMINAL 2

Littelfuse products are not designed for, and shall not be used for, any purpose (including, without limitation, automotive, military, aerospace, medical, life-saving, life-sustaining or nuclear facility applications, devices intended for surgical implant into the body, or any other application in which the failure or lack of desired operation of the product may result in personal injury, death, or property damage) other than those expressly set forth in applicable Littelfuse product documentation. Warranties granted by Littelfuse shall be deemed void for products used for any purpose not expressly set forth in applicable Littelfuse documentation. Littelfuse shall not be liable for any claims or damages arising out of products used in applications not expressly intended by Littelfuse as set forth in applicable Littelfuse documentation. The sale and use of Littelfuse products is subject to Littelfuse Terms and Conditions of Sale, unless otherwise agreed by Littelfuse.

Littelfuse.com